



Crane safety instrumentation

Calibration Instructions

**i4500 Rated Capacity Limiter/Indicator
for
telescopic cranes, pressure sensing
software ref sc122xxx**



Crane Warning Systems Atlanta
770-888-8083
www.craneindicators.com
sales@craneindicators.com



The purpose of this manual is to provide the calibration technician with the procedures essential for the promotion of proper machine operation for its intended purpose. The importance of proper usage cannot be overstressed.

The calibration technician should have read, and be familiar with, the instruction manual supplied with the system.

All information in this manual should be read and understood before any attempt is made to calibrate the machine.

Since the manufacturer has no direct control over machine application and operation, conformance with good safety practice in this area is the responsibility of the user and his operating personnel.

All procedures herein are based on the use of the system under proper operating conditions, with no deviations from the original design. Alteration and/or modification of the equipment are strictly forbidden without written approval from RaycoWylie Systems.

The i4500 RaycoWylie Systems Rated Capacity Indicator (RCI) is to be regarded only as an aid to the operator. When the parameters are set correctly, the indicator will warn the crane operator of an approaching overload condition that could cause damage to equipment, property, and/or injury to the operator or site workers in the vicinity of the crane and its load. Prior to the calibration being completed the system will not provide correct warnings and it is essential that other means are used to establish safe use of the machine.

This system must never be used, under any circumstances, as a substitute for the good judgment of a crane operator when carrying out approved crane-operating procedures. Responsibility for the safe operation of the crane lies with the crane operator. The indicator equipment will not necessarily prevent crane damage due to overloading and related causes if not set properly.

Before operating a crane equipped with a RaycoWylie system RCI, the operator must carefully read the information in the i4500 operator manual and the crane manufacturer operator's manual. He must also be aware of all the federal, state and local safety standard and regulations applicable to his job. Correct functioning of the system depends upon routine daily inspection.

Any suspected faults or apparent damage should be immediately reported to the responsible authority before using the crane.

TABLE OF CONTENTS

1	INTRODUCTION.....	7
1.1	Personnel qualification and scope of this manual	7
1.2	Using this manual	7
2	CONFIGURATION	9
2.1	Step #1: Accessing the calibration menu.....	9
2.2	Step #2: “Enable/Disable i/o” Setting	10
2.3	Step #3: “Calibration units” setting	12
2.4	Step #4: “Calibration data” Entry.....	13
2.5	Step #5: “Dimensions” Data entry	15
2.6	Step #6: “Block capacities and block weights” setting	19
2.7	Step #7: “System options” setting	20
2.8	Step #8: “Crane type” and “Enable/disable jibs”	21
2.9	Step #9: “Bridging/bypass output”	21
2.10	Step #10: “Picture”	22
2.11	Step #11: Set the clock	22
3	CALIBRATION.....	23
3.1	Step #12: “Zero sensor/Side of boom angle” angle sensor calibration	23
3.2	Step #13: “Zero sensor/Span sensor” length sensor calibration	25
3.3	Step #14: “Zero pressure/Span pressure” press. sensor calibration	27
3.4	Step #15: “Select boom output sequence”	29
3.5	Step #16: Main boom “No Load calibration”.....	31
3.6	Step #17: Main boom “Unloaded boom deflection”	39
3.7	Step #18: Main boom “Loaded boom deflection”	41
3.8	Step #19: Main boom “Load adjustment”	44
3.9	Step #20: Main boom “Load offset”	45
3.10	Step #21: Attachment “Jib deflection”	47
3.11	Step #22: Attachment “Load adjustment”	49
3.12	Step #23: Attachment “Load offset”	50
3.13	Step #24: “Friction compensation”	52
3.14	Step #25: “Transfer” Calibration backup	52
3.15	“Transfer” restoring calibration and load chart files	54

3.16 “Memory” 55

4 OPTIONS 56

4.1 “Limits setting” parameters 56

4.2 “Special calibration” 56

4.3 “Users ID” Setting user pass codes for the data logger 56

4.4 “Rotation data” 57

5 AUTOMATIC LOGS..... 60

5.1 “Fault log” 60

5.2 “Event recorder” 60

6 ANNEX 1 – Calibration of Main boom “Load correction” 61

7 ANNEX 2 – Menu cross reference..... 66

1 INTRODUCTION

This manual contains calibration information for the i4500 system. When performing calibration of the i4500 system, always observe the safety rules and regulations applicable in the country of operation to reduce the risk of personal injury or damage to the equipment. Each safety instruction throughout this manual must be taken into consideration when using the i4500 system. The information contained in this manual will enable qualified personnel to properly operate and efficiently perform calibration.

1.1 Personnel qualification and scope of this manual

Installation of the i4500 system shall be performed by a qualified technician. Furthermore, calibration of the i4500 system **must be** performed by a **RaycoWylie** trained technician. The **RaycoWylie** technician will perform a complete and structured verification of the whole system before beginning the system's calibration.





Failure to calibrate the system properly can result in overloading of the crane risking machine breakage or tipping that could result in serious injury or death. Always refer to a **RaycoWylie** trained technician to calibrate your system.

1.2 Using this manual





This manual must be used in conjunction with the Instruction Manual, refer to the instruction manual for description of the system operation, especially the section "Operating Buttons Description".

Screenshots used in this manual are taken from a 4.3" display and some screens may vary on larger display versions; calibration procedures, descriptions and functions are identical for all display versions. All numbers shown on sample screens are examples only and must be substituted with real information from the machine.

Navigating screens and editing data:

	UP button. Press to move up the screen when in a menu or to increase the value of a highlighted number.
	DOWN button. Press to move down the screen when in a menu or to decrease the value of a highlighted number.
	ESCAPE button. Press to exit a menu or to escape an option without saving.
	SELECT button. Press to enter a selection when in a menu or to accept a changed value. Note that most changed values must also be saved to permanently store them.

Additional buttons used in the calibration mode only, refer to relevant text for detailed use:

	SAVE button. Press to save all recent changes into memory.
	DELETE button. Press to delete a stage of some calibrations.
	CLEAR button. Press to clear the fault log or the event log.
	CHANGE SIGN button. Press to set a variable to negative or back to positive.

2 CONFIGURATION

To ensure a successful, first calibration follow each calibration step in sequence, do not miss out any steps unless they are marked as optional.

Many calibration screens show reminder notes or hints on the bottom line, remember to read these for guidance.

2.1 Step #1: Accessing the calibration menu

- 1- Press the Mode button.
- 2- Scroll to highlight "Calibration Mode" using "↑" or "↓".
- 3- Press "✓" to enter this menu.
- 4- The system will request a 5 digit password. The first digit will be highlighted, use "↑" or "↓" to select the first digit and press "✓" to confirm and move on to the second digit. Repeat this for all 5 digits, after confirming the 5th digit the system will enter the calibration menu provided the password is correct. If the password is not correct the system will return to the normal working screen.
- 5- If a mistake is made while entering the password, press "←" to return to the previous digit.

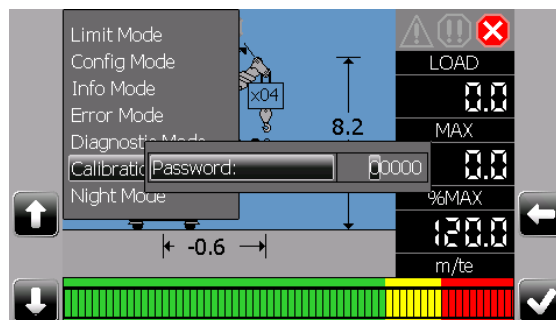

Some systems are installed with dual level password access, this manual includes information on all features accessible from the top level. Some features will not be available when the lower level password is entered and will not appear in the calibration menu. It will not normally be necessary to access these features after the initial installation is completed.

Provided the top level password is used the calibration menu will remain accessible until the system is powered off otherwise the password will be required every time the menu is selected.

2.2 Step #2: "Enable/Disable i/o" Setting

Note: these settings reflect the configuration of your system and will generally be made during factory testing prior to delivery and should not need changing.

- 1- In the calibration menu, scroll up or down to the menu "Enable/Disable i/o".
- 2- Press "✓" to enter this menu.
- 3- Scroll to select the I/O option to edit.
- 4- Press "✓" to highlight the value to edit. Scroll up or down to change to value then Press "✓" to confirm.
- 5- Any change made must be permanently registered by pressing the "save" button.
- 6- Press "←" at any time to abandon any changes not saved or to exit the menu when done.

As a guide, the minimum requirements for a basic system are:

Angle 1	ON
Length 1	ON
Load 1	ON
Load 2	ON
Relay board 1	ON

All remaining items in the list are optional and set to OFF if not used.

Refer to the wiring diagram supplied with your system to determine which I/O should be enabled, this will be indicated by a table or a notation adjacent to each component. See example below: (Ref Load 1 and Load 2) means that these two I/O items need to be ON.

CANbus LOAD CELL INTERFACE (Ref Load 1 and Load 2) 33M0090

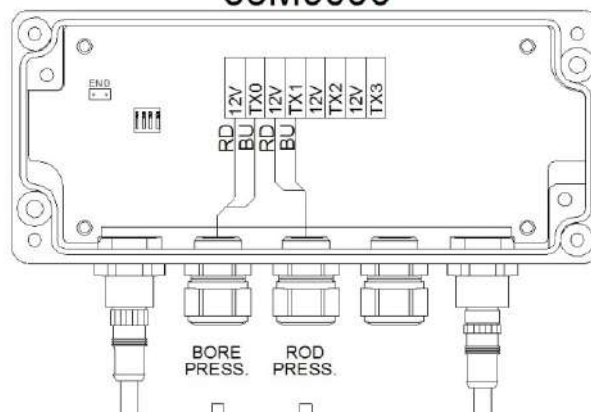

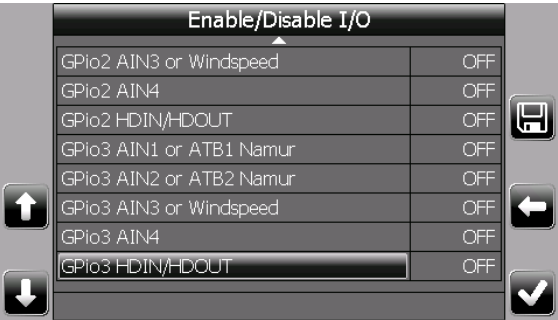
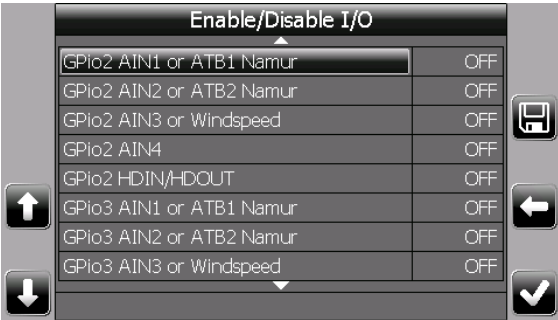
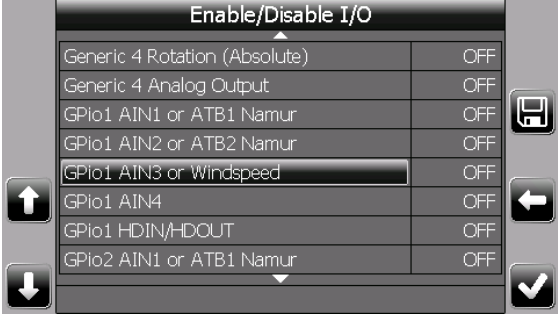
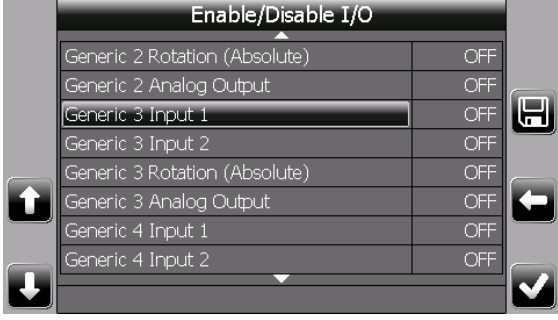
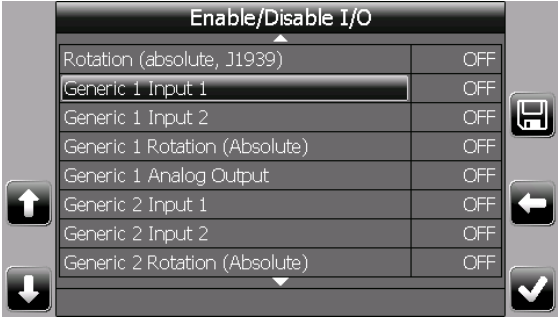
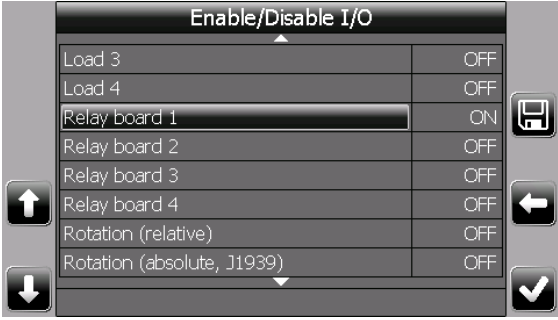
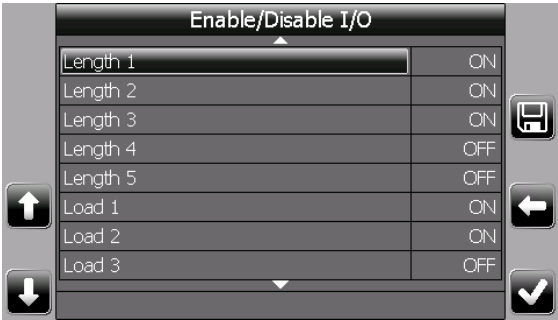
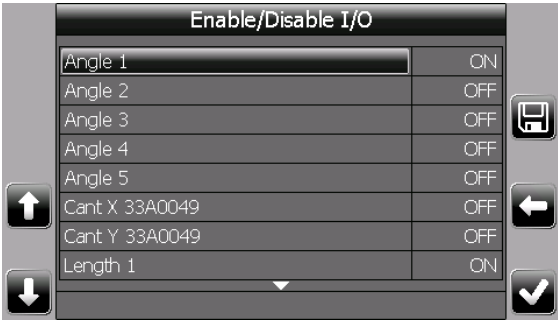

For the Generic and GPIO items there are various configuration options available once enabled, refer to the system wiring drawing for details of which selection to set.

GPio HDIN's configuration

If GPio HDIN/HDOOUT is set to ON in any of the above screens then an extra menu option will appear in the main calibration menu to configure the use of the HDIN/HDOOUT connections.

Scroll to "GPio Hdins configuration" and press "✓" to enter, the screen will show options to set each GPio that has HDIN/HDOOUT set to ON:

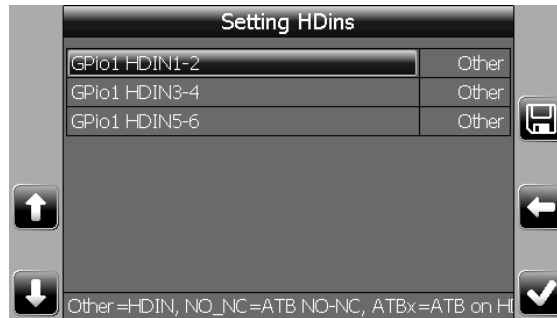

Select the pair of inputs required, press "✓" to highlight the option currently set, use "↑" or "↓" to scroll through the available options and then press "save" when the required option is displayed. Refer to the wiring drawing supplied for the necessary settings for your system.

Warning: these settings must match the relevant wiring drawing for proper operation of the i4500 system.

2.3 Step #3: "Calibration units" setting



- 1- In the calibration menu, scroll up or down to the item "Calibration units:".
- 2- Press "✓" to toggle between metric and imperial.

imperial: use x1000lbs and feet.
metric: use metric tons and metres (1 metric ton = 1000 kg).

2.4 Step #4: "Calibration data" Entry

Some or all of this information may be pre-loaded prior to delivery but all entries should be verified and edited as required before proceeding. Length units in use will be feet or metres depending on the setting made for 'calibration units' in step #3, a reminder is shown on the bottom line of this display. **Remember to save any changes made.** Please advise Rayco Wylie of any changes required in this section.

- 1- In the calibration menu, scroll down to the item "Calibration data:".
 - 2- Press "✓" to enter this menu.
 - 3- Scroll to select the item to edit from the list below.
 - 4- Press "✓" to highlight the value to edit. Scroll up or down to change the value then Press "✓" to confirm.
 - 5- Any change made must be permanently registered by pressing the "save" button.
 - 6- Press "←" at any time to abandon any changes not saved or to exit the menu when done.
- **Rope limit Main:** This is the maximum tension that the cable is rated for per fall or part of line (rope SWL) for the main rope. Note that this value will be monitored simultaneously with the relevant load table and the hook capacity, the lowest of these figures will be used as the current SWL for alarm purposes.
 - **Rope limit Aux:** This is the maximum tension that the cable is rated for per fall or part of line (rope SWL) for the auxiliary rope. Note that this value will be monitored simultaneously with the relevant load table and the hook capacity, the lowest of these figures will be used as the current SWL for alarm purposes.
 - **Max parts of line:** This is the maximum number of parts of line that can be rigged on the crane and applies to all hoists.
 - **Percent per part:** This value allows a reduction in the SWL of the hoist rope when reeved to more than 1 part, the factor is applied to both main and auxiliary hoists. For example: entering a value of 1.0 in this field will mean that the maximum load on 1 part will be the rope limit described above, the maximum load on 2 parts will be two times the rope limit less 1.0%, the maximum load on 3 parts will be three times the rope limit less 2%, the maximum load on 4 parts will be four times the rope limit less 3% etc.
 - **Alarm 1:** Is the %SWL approach limit. If the %SWL is greater than Alarm 1, an intermittent audible alarm will be activated and the yellow display LED will blink. The external yellow lamp output will be ON.
Note: %SWL = (Load / Capacity) x 100.

- **Alarm 2:** Is the %SWL overload limit. If the %SWL is greater than Alarm 2, a continuous audible alarm will be activated and the red display LED will be ON. The external red lamp and audible alarm output will be ON.
- **Alarm 3:** Is the %SWL motion cut limit. If the %SWL is greater than Alarm 3, a continuous audible alarm will be activated and the red display LED will be ON. The external red lamp and audible alarm output will be ON. The motion cut output will be in the stop condition (cut active).
- **Gap for Multi-Reel (UnLocked):** This value is only valid if more than one boom length sensor (extension reel) is fitted and represents the tolerance allowed for the position of the non-telescoping section(s) during the no load calibration procedure. If the fixed boom sections are moved out of tolerance the calibration process will be suspended until the situation is corrected. It is also used in the selection of the appropriate load table, the actual switch over point between tables is the nominal boom extension % plus this value.
- **Gap for Multi-Reel (Locked):** This value is used as an alternative to the Unlocked value if the load table is set to 'pinned' in the chart file.
- **Outside duty radius:** This variable must be set to zero.
- **Outside duty angle:** This variable must be set to zero.
- **Outside duty length:** This variable represents an upper tolerance on the automatic selection of the relevant load capacity chart for the actual boom length measured by the system length sensor.
- **Inside duty length:** This variable represents a lower tolerance on the automatic selection of the relevant load capacity chart for the actual boom length measured by the system length sensor.
- **Number of hoists:** Set to the number of hoists (winches, or hooks) fitted to the crane, 1 for main hoist only or 2 for main and auxiliary hoists.
- **Duty change >20% SWL:** If set to ON this option allows duty and parts settings to be changed while a load is suspended, if set to OFF these changes will not be permitted unless the load is less than 20% of the SWL.
Warning: This option must be set to **OFF** for European operation.
- **Sensitivity coefficient (5-50%):** The % value will determine how much variation is required in order for the load variation to be outside the range of the filter, this should be left at the default value of 35. The filter will only be functional in the normal operating mode.
- **Low frequency Coefficient (10-75):** Adjusts the number of samples the filter will use, this should be left at default value of 35. The filter will only be functional in the normal operating mode.

2.5 Step #5: "Dimensions" Data entry

This menu contains crane dimensions that are necessary for the calculation of the load on the hook, based on the hydraulic cylinder pressure. This data refers to the winch and boom hoist cylinder geometry at the superstructure and some main boom dimensions. Some or all of this information may be pre-loaded prior to delivery but all dimensions should be verified and edited as required before proceeding. Units in use will be feet or metres depending on the setting made for 'calibration units' in step #3, a reminder is shown on the bottom line of this display. To enter a negative value, enter the numerical value and press +/- to change to negative (only available if relevant).

Remember to save any changes made. Please advise Rayco Wylie of any changes required in this section.

Dimensions relating to boom tip attachments are stored in the chart file and are not editable in this menu, **see note 2 (page 18)*.

- **CL1 (full retract):** length of the main boom when fully retracted.
- **CL2 (full extend with extension):** length of the boom with all sections fully extended including any manual or power pinned extension if fitted.
Special case: For booms with two telescoping ranges eg mode A with top section pinned closed and mode B with top section included in telescoping, set CL2 to max boom length with top section closed.
- **CL2MR (full extend w/o extension):** length of the boom fully extended but with any manual or power pinned extension retracted. Note: For full power booms without a manual section **CL2** and **CL2MR** are the same value.
Special case: for booms with two telescoping ranges as above, set CL2MR equal to CL2.
- **CL3 (p2blh)** – horizontal distance between the boom foot pin and lift cylinder base pin.
- **CL4 (p2blv)** – vertical distance between the boom foot pin and lift cylinder base pin.
- **CL7 (p2buh)** – distance between the boom foot pin and lift cylinder top pin parallel to boom telescoping centerline.
- **CL8 (p2cb)** – vertical distance between the boom foot pin and the boom centerline with the boom horizontal. Instead of using the boom centerline as a reference, It is common to use the boom foot pin, in this case CL8 = 0 but ensure that CL9, CL10 and CL11 all use the same reference.
- **CL9 (ra2cb)** – vertical distance between the lift cylinder top pin and the boom centerline (or boom foot pin, see CL8) with the boom horizontal. If the boom centerline is higher than the lift cylinder top pin, then the distance is positive, otherwise it is negative.
- **CL10** - vertical distance between the lower boom tip sheave pin (hook suspension sheave) and the boom centerline (or boom foot pin, see CL8) with the boom horizontal.
- **CL11** - vertical distance between the upper boom tip sheave pin and the boom centerline (or boom foot pin, see CL8) with the boom horizontal.

- **CR1** - lower boom tip sheave pitch radius (hook suspension sheave).
- **CF (slew offset)** – horizontal distance between the boom foot pin and the centerline of rotation of the machine. If the boom foot pin is behind the centerline of rotation then the distance is negative, otherwise it is positive.
- **CH1 (height rubber)** – vertical distance between the boom foot pin and the ground when on tires.
- **CH2 (height outrigger)** – vertical distance between the boom pivot pin and the ground when on outriggers.
- **NR (number of rams)** – number of boom lift cylinders, normally 1 or 2.
- **RD (rod diameter)** – rod diameter of the lift cylinder.
- **BD (bore diameter)** – bore diameter of the lift cylinder.
- **CR2M (m.h. radius)** – radius of the main hoist drum from the center to the middle of the hoist line layers.
- **CL5M (p2mhh)** – horizontal distance between the center of main hoist drum and the boom foot pin. If the drum is mounted on the boom, this dimension is zero.
- **CL6M (p2mhv)** – vertical distance between the center of main hoist drum and boom foot pin. If the drum is mounted on the boom, this dimension is zero.
- **CR22M** – radius of the boom base mounted main hoist guide sheave, **see note 1*.
- **CL28M** – vertical distance between the boom base mounted main hoist guide sheave and the boom foot pin measured when the boom is horizontal. **see note 1*.
- **CL29M** – horizontal distance between the boom base mounted, main hoist guide sheave and the boom foot pin measured when the boom is horizontal. **see note 1*.
- **CR2A (a.h. radius)** – radius of the auxiliary hoist drum from the center to the middle of the hoist line layers.
- **CL5A (p2ahh)** – horizontal distance between the center of the auxiliary hoist drum and the boom pivot pin. If the drum is mounted on the boom, this dimension is zero.
- **CL6A (p2ahv)** – vertical distance between center of auxiliary hoist drum and boom pivot pin. If the drum is mounted on the boom, this dimension is zero.
- **CR22A** – radius of the boom base mounted, auxiliary hoist guide sheave, **see note 1*.
- **CL28A** – vertical distance between the boom base mounted, auxiliary hoist guide sheave and the boom foot pin measured when the boom is horizontal. **see note 1*.
- **CL29A** – the horizontal distance between the boom base mounted, auxiliary hoist guide sheave and the boom foot pin measured when the boom is horizontal. **see note 1*.

**Note 1: This option is rare and these values are generally set to zero. If a guide sheave is fitted but mounted on the superstructure (not the boom) then the sheave is treated as though it is the winch drum (see sketches).*

**Note 2: The chart file that contains all the relevant load charts and duty information for the machine also contains dimensions, weights and center of gravity for all the boom top attachments (fly jibs etc.). In some cases some of this data may not have been available during the system configuration at the factory. In these cases it will be necessary to obtain the information by surveying the hardware on site, the attending Rayco Wylie technician will be equipped to update the load chart file with this data. In the event of a Rayco Wylie technician not attending please refer to the dimension sheet and contact Rayco Wylie Systems technical service and provide them with the missing dimensions and weights. The load chart file will be updated with the verified information and returned via email. Before calling please take note of the technical file reference (TF-xxxxx) and serial number located on the serial number label of the display, alternatively, go to the diagnostics screen, select 'system' and note the full name of the load chart file given there. This will enable our Technical Service representative to efficiently access all the information about the system.*

Base boom geometry

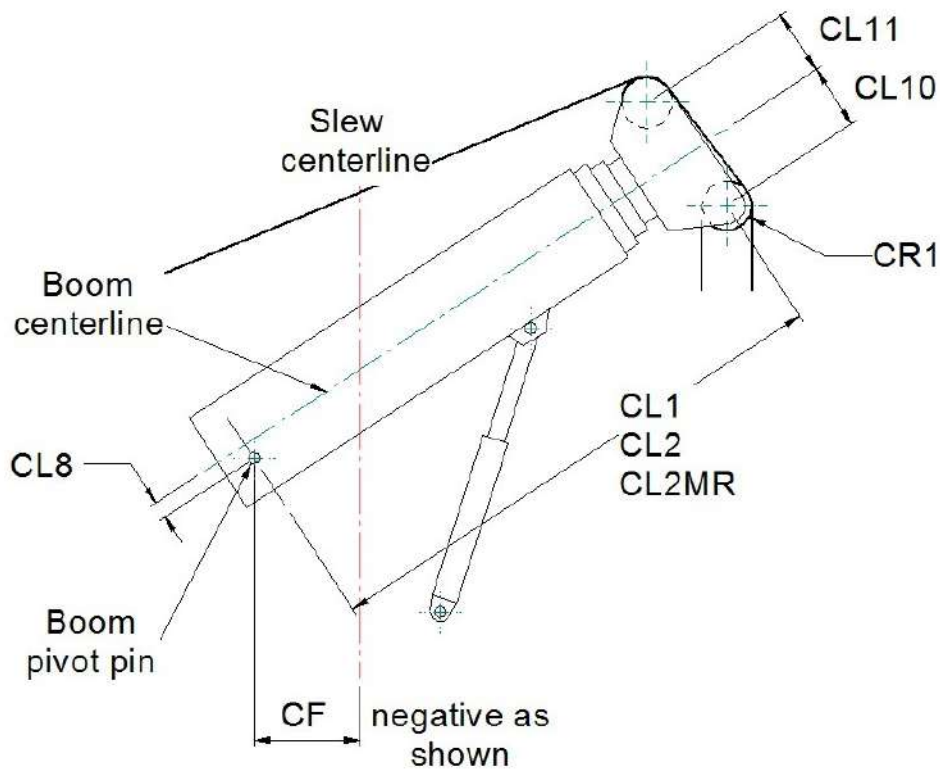

Note sign convention: All dimensions shown positive except **CF**, the centreline of slew is generally in front of the boom pivot pin in which case **CF** is negative. If any dimension falls the opposite side of it's datum line shown in the diagrams then it's sign will change eg if the top of the boom lift cylinder is above the centreline of the boom then CL9 will be negative etc.

Boom hoist cylinder geometry

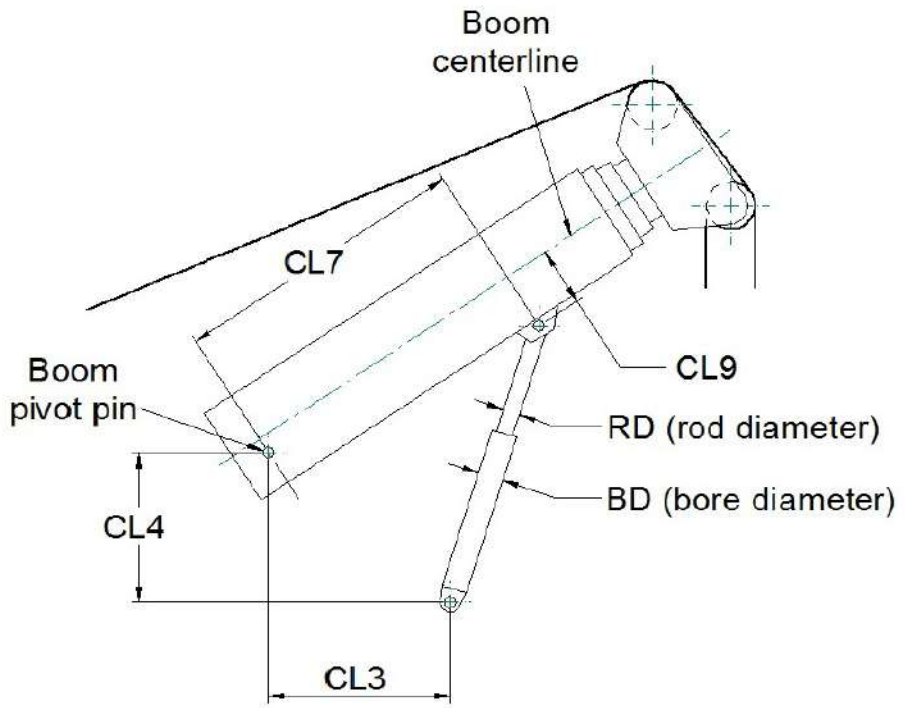

Winch geometry
Winches or guide sheaves on superstructure

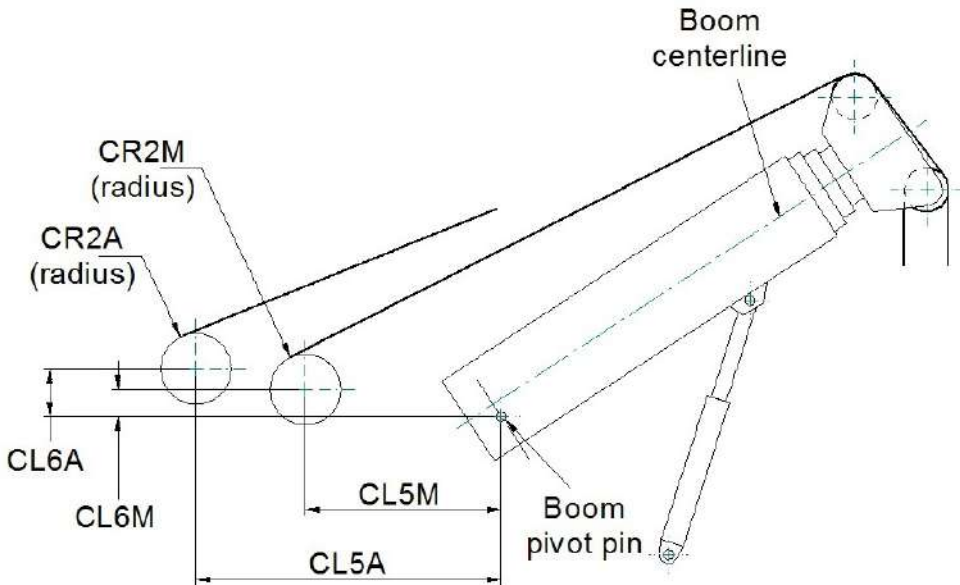

Additional winch geometry

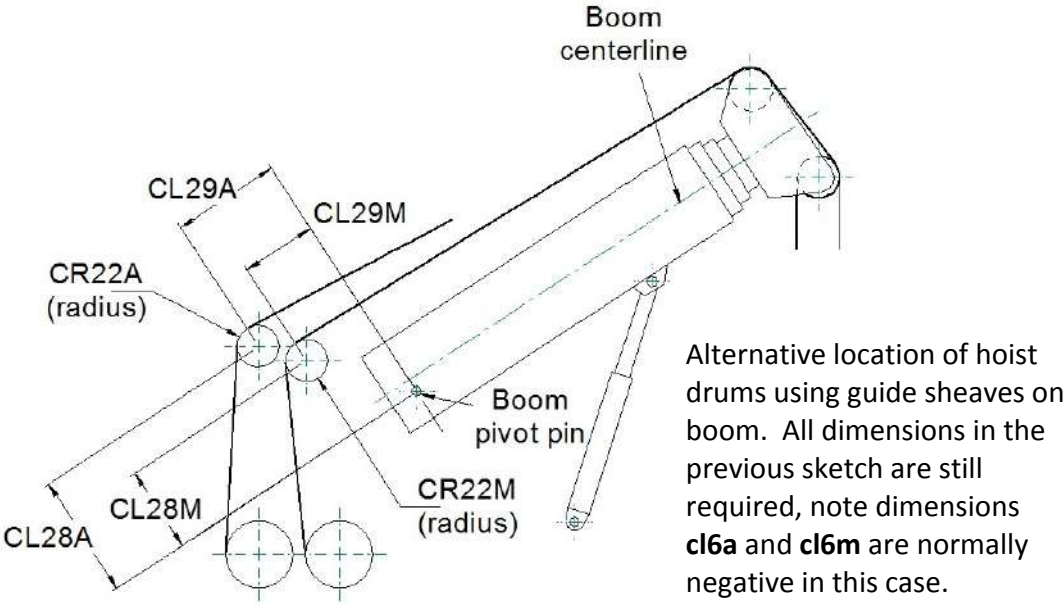

2.6 Step #6: “Block capacities and block weights” setting

This menu contains the capacities and weights of all the available hooks for the crane, the hook(s) in use must be entered here for subsequent selection in the configuration setting of the system. The capacity of each hook will be used by the i4500 system to determine whether the current SWL for the configuration and position of the machine is limited by the load curve, the parts of line or the hook capacity. The weight of the selected hook will be used in the calculation of the load if set as an ‘unused hook’ in the duty wizard, refer to operation manual.

After selecting “block capacities and block weights” from the main calibration menu the screen will show:

Block capacities and Block weights	
Capacity of block 1	40.00
Weight of block 1	0.50
Capacity of block 2	6.00
Weight of block 2	0.25
Capacity of block 3	0.00
Weight of block 3	0.00
Capacity of block 4	0.00
Weight of block 4	0.00
Enter value in te	

Set the capacity and weight of each hook block in turn using the calibration units set earlier (noted at the bottom of this screen). Remember to press “save” once all the data is entered. Numbers shown are for illustration purposes only and must be set to show real data from the machine.

2.7 Step #7: “System options” setting

The system options menu allows various features to be turned on and off and may vary depending on the version of software installed in the i4500 system. **These settings will normally be pre-set before delivery and will not require changing.**

Navigate through the calibration menu using “↑” or “↓” to highlight “system options” and press “✓” to enter.

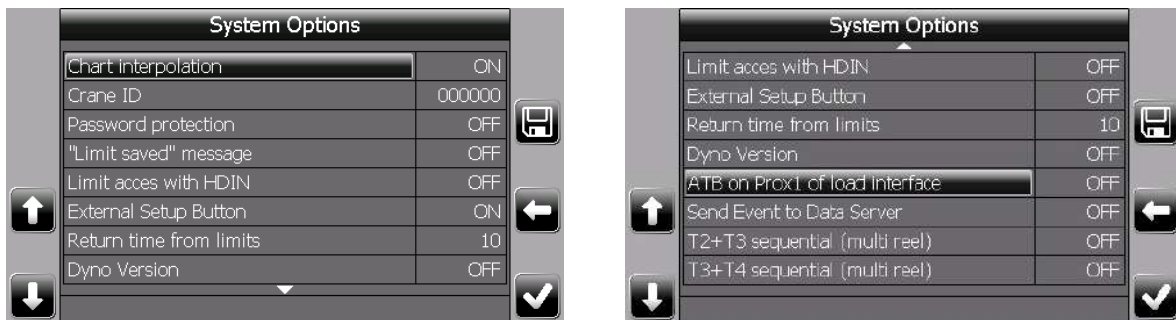

Chart interpolation. Determines whether or not the i4500 system interpolates the crane capacity charts with respect to radius/angle or whether it steps from one capacity to the next. If chart interpolation is ON, the system will display a smooth transition between rated points. If it is OFF, then once the radius/angle exceeds a listed value on the chart the capacity will drop to the next rated capacity, this is known as a stepped chart. Refer to the crane manufacturer’s load chart to determine if the charts should be interpolated or stepped.

Crane ID. This is a unique identifier for the crane. It is used in conjunction with the EN13000 logger and/or the Rayco Wylie data logger software for PC to manage ‘whole life’ data for the machine and acts as an identifier for files once downloaded and removed from the machine. Enter a unique reference for the machine eg crane serial number or fleet number etc.

Password protection. This is only used if a datalogger is installed and, when set to ON, will set the system to ask for a pass code number to be entered each time the system is switched on. See also “user id” settings (page 60).

“Limit saved” message. Optional feature, if enabled then setting this to ON will display a message on start up indicating a limit is saved if a limit has previously been set.

Limit access with HDIN. When set to ON, Limits/Range limiting menu is accessed via an external input rather than the normal menu button. Refer to the wiring diagram for details if relevant. Normally set to ON if range limiting is fitted.

External setup button. Optional feature, if enabled then setting this to ON will allow the setup bypass feature to be available via an external digital input.

Return time from limits. Not enabled unless the range limiting feature is fitted. This value represents the time allowed between setting a range limit and the limit becoming active to allow the machine to be moved back into the permitted working zone.

Dyno version. **Must be set to OFF** for this pressure sensing version of the i4500.

ATB on Prox1 of load interface. Optional feature, set to OFF unless load interface module is configured to control the ATB signal. Refer to system wiring drawing supplied.

WARNING: This setting must match the relevant wiring drawing for proper operation of the i4500 system.

Send Event to Data Server. Optional feature, set to OFF unless an external modem is fitted to the system. Refer to system wiring drawing supplied.

T2+T3 sequential (multi-reel). Optional feature; only relevant if two boom length sensors (extension reels) are fitted. Used to display T2 and T3 boom sections sequentially rather than sympathetically. When set to OFF, T2 and T3 displays will both display the same number from 0 – 100%. When set to ON, T2 will display 0-100% and T3 will remain at 0%, then, when T2 = 100%, T3 will display 0-100%.

T3+T4 sequential (multi-reel). Optional feature; only relevant if three boom length sensors (extension reels) are fitted. Used to display T3 and T4 boom sections sequentially rather than sympathetically. When set to OFF, T3 and T4 displays will both display the same number from 0 – 100%. When set to ON, T3 will display 0-100% and T4 will remain at 0%, then, when T3 = 100%, T4 will display 0-100%.

WARNING: These last two settings are mutually exclusive and must match the relevant chart file for proper operation of the i4500 system.

2.8 Step #8: “Crane type” and “Enable/disable jibs”

These items are options depending on the version of the software installed. When available they allow the selection of one or more crane models within a single manufacturer’s range to allow for differences in required features and also add the ability to add or subtract jib sets from the duty wizard. They must be set to precisely match the crane model to which the i4500 system is fitted.

2.9 Step #9: “Bridging/bypass output”

This item is an option depending on the version of the software installed. When available it allows the parameters to be set for the PWM output used to reduce the machine speed during bridging or bypass functions.

2.10 Step #10: "Picture"

This setting allows the graphic of the crane shown in the normal working window to be set to a version that looks similar to the machine to which the system is fitted. It can be set to any of the available choices at any time without changing the performance of the system.

2.11 Step #11: Set the clock

The clock must be set to the correct local time and date to ensure any data recorded by the EN13000 and/or data logger is simple to analyze. It is not necessary to be in the calibration mode of the i4500 for this setting, see also "System configuration mode settings" section of the instruction manual.

- 1- Press the Mode button.
- 2- Scroll to highlight "Config Mode" using "↑" or "↓".
- 3- Press "✓" to enter this menu, scroll down to "Date and Time" and press "✓" again.

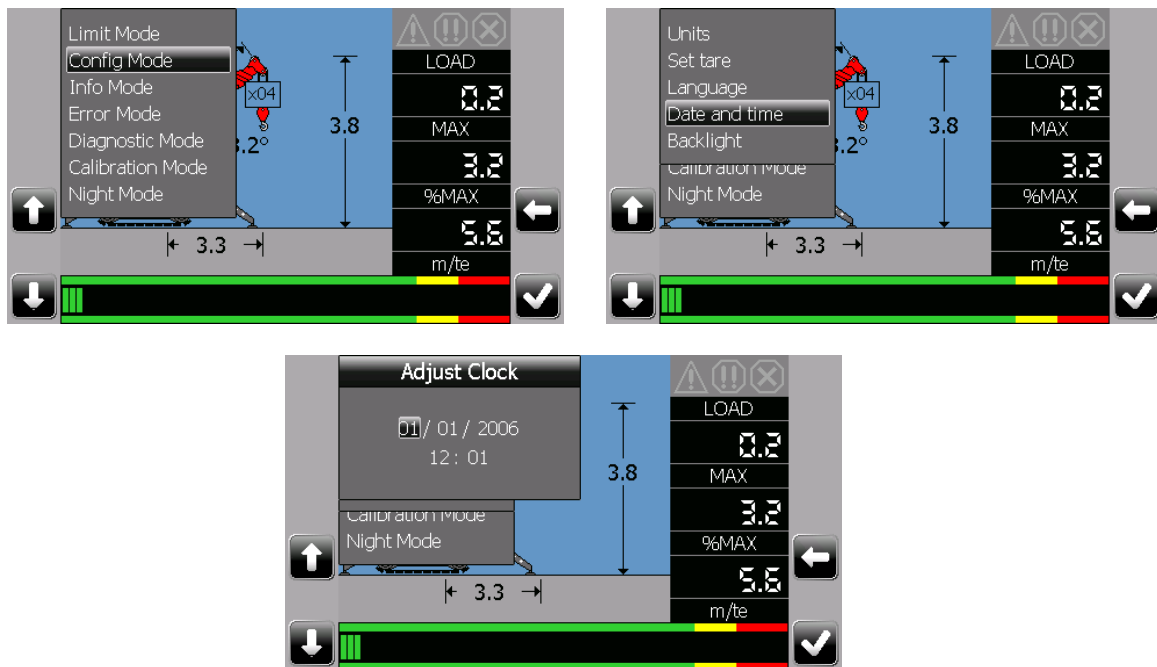

The date fields are displayed mm/dd/yyyy and the time fields are displayed hh:mm using the 24 hour clock. Set each highlighted field in turn using the "↑" or "↓" buttons to select the value and the "✓" button to save each setting and move to the next field. The screen will return to the main screen after the minutes have been set. Press "←" at any time to exit to the main screen.

3 CALIBRATION

3.1 Step #12: “Zero sensor/Side of boom angle” angle sensor calibration

Address selection dip switch:

Every angle sensor installed has its own dedicated address. These switches are factory set prior to dispatch and will not normally require changing. Please refer to the wiring diagram to see the address dip switch setting for each angle sensor interface.

Angle Sensor Side of Boom:

- 1) Use “↑” or “↓” to choose “select sensors” and press “✓”.

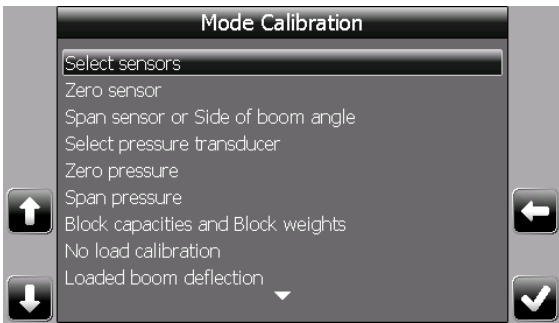

- 2) Use “↑” or “↓” to choose the relevant angle sensor and press the “✓”.

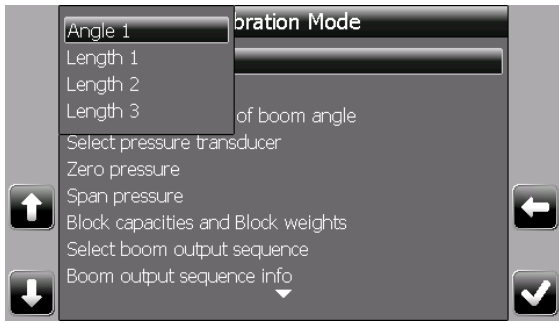

- 3) Use “↑” or “↓” to choose “span sensor or side of boom angle” and press “✓”.

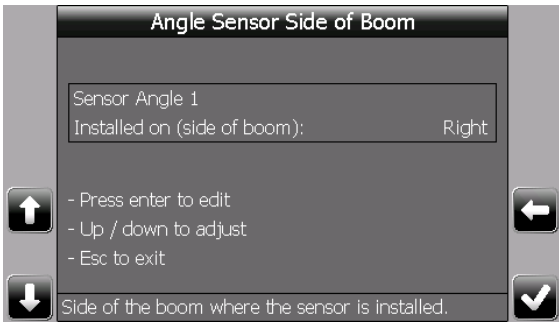

- 4) Press “✓” to highlight the value to edit and use “↑” or “↓” to edit the location of the angle sensor (normally integrated into the length sensor (reel)), press the “✓” to confirm and then “←” to exit.

Note, “right” indicates right hand side of boom when viewed from the operator’s cab.

Zero angle calibration:

Ensure the correct side of boom setting has been made before setting the zero datum, if the side of boom setting is changed then the zero setting must be repeated.

- 1) Use “↑” or “↓” to choose “Zero sensor” and press “✓”.

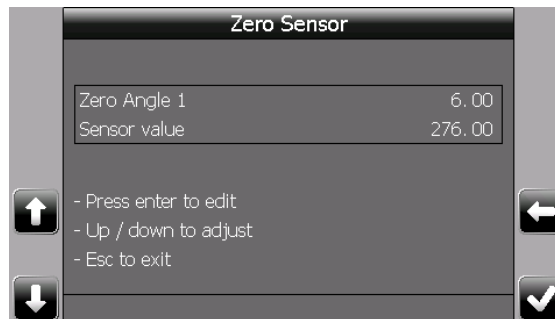

- 2) Boom down to zero degrees (main boom horizontal) using a precision angle measure to accurately establish the true angle of the base boom section. The angle is displayed in degrees and the sensor value is in bits. This value must be above 100 bits. If smaller, turn the sensor to increase the value.
- 3) Press “✓” to edit the angle value using “↑” or “↓”.
- 4) Press “✓” again to confirm the zero.
- 5) Press “←” to return to the main calibration menu.

The boom angle need not be zero but it’s true value must be accurately known and entered as described.

Note that the angle sensor(s) do not require a span calibration.

Repeat step #12 for each angle sensor in turn.

3.2 Step #13: “Zero sensor/Span sensor” length sensor calibration

Warning: The system does not store the ZERO LENGTH into permanent memory until the SPAN LENGTH calibration has been completed. If a ZERO LENGTH calibration is done, then a SPAN LENGTH calibration must also be done.

Zero extension calibration:

- 1) Use “↑” or “↓” to choose “Select sensors” and press “✓”.
- 2) Use “↑” or “↓” to choose the relevant length sensor to be calibrated, press “✓”.
- 3) Use “↑” or “↓” to choose “Zero sensor” and press “✓”.

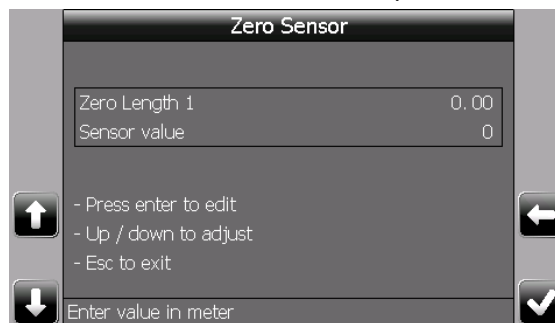

- 4) Retract the boom completely. The sensor’s value must be approximately 100 bits (0,50 volts; adjust the potentiometer inside the cable reel if necessary).
- 5) Edit the zero value: when the boom is completely retracted, the value must be set to zero.
- 6) Press “✓” to confirm the value. Note the indicated value will return to it’s earlier state temporarily, the new zero value will be stored after the next step.
- 7) Press “←” to return to the main calibration menu.

Span extension calibration

- 1) Use “↑” or “↓” to choose “span sensor or side of boom angle” and press “✓”.

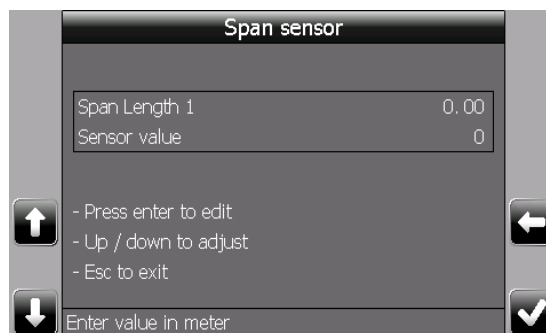

- 2) Fully extend all the boom sections up to and including the section that the length sensor cable is attached to. For booms with a manual section, this section can remain retracted but the span value must equal the telescoping range excluding the manual section. The sensor value should be a minimum of 150 bits above

the zero value. Enter the difference between the extended and retracted boom lengths using the units shown at the bottom of the screen. For example: A fully extended boom of 30m minus a fully retracted boom of 10m = 20m. Enter 20.0 for the span extension.

- 3) Press “✓” to edit the span value.
- 4) Edit the span value, then press “✓” to confirm the value.
- 5) Press “←” to return to the main calibration menu.

Repeat step #13 for each length sensor in turn.

3.3 Step #14: “Zero pressure/Span pressure” press. sensor calibration

This step is only required for pressure transducers with mV output. For transducers with 4-20mA or J1939 outputs calibration is not required, go to Step #15.

Select the transducer to be calibrated

- 1) Use “↑” or “↓” to choose “Select pressure transducer” and press “✓”.

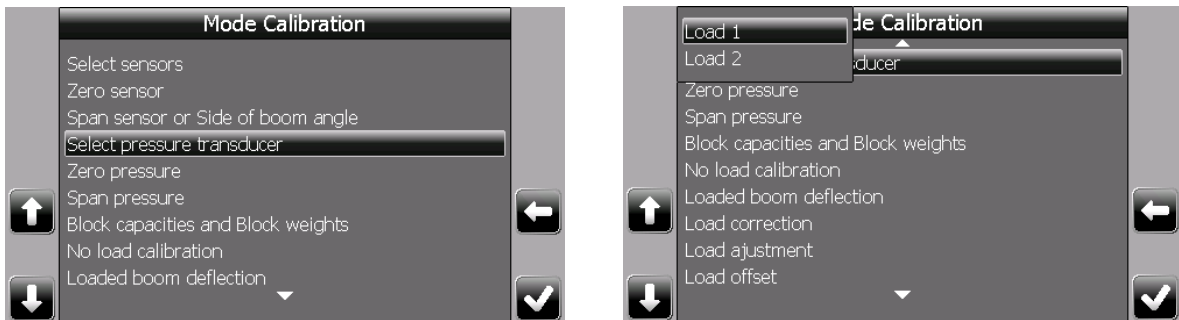

- 2) Use “↑” or “↓” to choose the Load 1(Bore), or Load 2(Rod), sensor and press “✓”.

Zero pressure calibration:

- 1) Use “↑” or “↓” to choose “Zero pressure” and press “✓”.

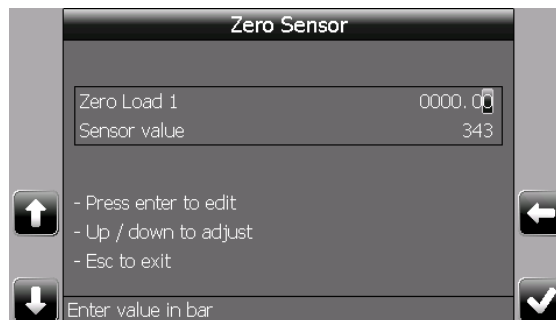

WARNING Make sure the boom is mechanically supported by the cylinder stops to prevent a sudden fall when the residual hydraulic pressure is released.

To zero the pressure sensors, open the hydraulic lines of both sensors in order to remove any residual pressure.

The pressure sensor must be electrically connected according to the wiring drawing supplied for normal operation.

The reading on the Sensor value is in bits and the maximum scale value is 4095. For the zero setting the display should read between 175 and 300 bits. The units are shown at the bottom of the screen and are in bar for metric calibration units and psi for imperial calibration units.

- 2) Press “✓” to edit the zero value.
- 3) Edit the zero value to read 0000.00, then press “✓” to confirm the value.
- 4) Press “←” to return to the main calibration menu.

Warning: The system does not store the ZERO PRESSURE into permanent memory until the SPAN PRESSURE calibration has been completed. If a ZERO PRESSURE calibration is done, then a SPAN PRESSURE calibration must also be done.

Span pressure calibration:

- 1) Use “↓” to choose “Span pressure” and press “✓”.



The pressure sensor must remain disconnected from the hydraulic line. In the pressure transducer interface box, turn the RCAL switch to ON if available or temporarily connect the black and white wires of the relevant pressure sensor together.

As above, the reading on the bottom line represents the current bits value of the sensor, for the span setting the reading should be above 3200 and not exceed 3850. If the reading is outside of these values then adjust the gain setting jumpers in the transducer interface unit to achieve the closest possible setting, refer to the label inside the interface unit for guidance. The standard gain setting number is 325, other options are 219, 253, 413, 579 and 630; a higher gain setting will result in a larger span setting value.

- 2) Press “✓” to edit the span load value.
- 3) Edit the value to match the figure engraved on the pressure sensor, a typical value will read: CAL 285.6 bar. If there are two lift cylinders and one pressure sensor on the bore side of each cylinder connected in parallel, enter the average of the 2 engraved values.
- 4) Press “←” to return to the main calibration menu.
- 5) Turn the RCAL switch to OFF if available or put the black and white transducer wires to their original connections and reconnect the hydraulic line.

Repeat step #14 for each pressure sensor in turn.

3.4 Step #15: “Select boom output sequence”

This section is only necessary and available if there is more than one boom extension reel fitted, if there is only one reel go to step #16.

For machines with more than one length sensor (reel), multiple no load calibrations must be made depending on the boom telescoping sequence.

For Example 1, using 2 reels: a machine has a five section boom, section 1 being the base section, section 2 being the first telescoping section, and sections 3,4 and 5 being a second, sympathetically linked, telescoping set. In this case one reel will monitor the first telescoping section, and a second will monitor the whole boom to section 5. One no load calibration procedure is done using sections 3,4 and 5 telescoping and with the section 2 fully retracted, a second is done using sections 3,4 and 5 telescoping and with the section 2 fully extended. These two calibrations are selected using “select boom output sequence”.

Example 2, using 3 reels: a machine has a four section boom, section 1 being the base section and sections 2,3 and 4 being independently telescoped sections that can be used in any combination. In this case reel 1 will monitor section 2, reel 2 will monitor section 3 and reel 3 will monitor section 4. Four separate no load calibrations are required for this example, two of the reels will be required to be stationary while the third is telescoped for the calibration described in the next step. This process will vary depending on the machine design and the appropriate settings will be displayed as shown in the example screen below. In this example the choices offered are:

T1 (0%), T2 (0%), T3. Means reel 1 and reel 2 should be at zero extension and reel 3 telescoped for the calibration.

T1 (0%), T2 (100%), T3. Means reel 1 should be at zero extension, reel 2 at max extension and reel 3 telescoped for the calibration.

T1 (100%), T2 (0%), T3. Means reel 1 should be at max extension, reel 2 should be at zero extension and reel 3 telescoped for the calibration.

T1 (100%), T2 (100%), T3. Means reel 1 and reel 2 should be at max extension and reel 3 telescoped for the calibration.

Use “↑” or “↓” to choose “Select boom output sequence” and press “✓”.

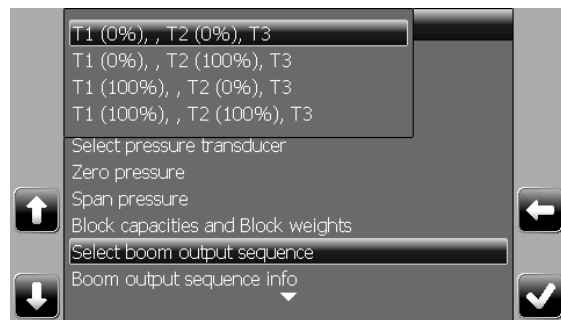
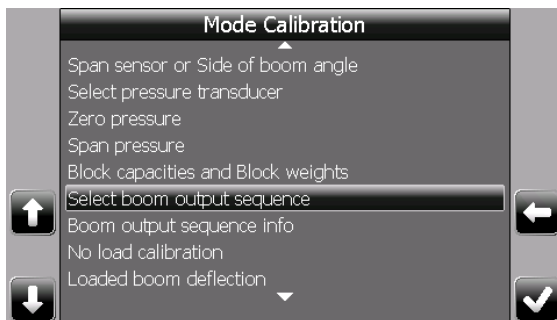

Use “↑” or “↓” to choose the sequence to be calibrated and press “✓”.

Complete the no load calibration, step #16, and then return to this step to select the next sequence, repeat the no load calibration procedure for each available sequence.

Note that these calibrations can be completed in any order but all must be done, while the calibration conditions may not all be working conditions they will form the base line no load pressure maps for all working conditions.

“boom output sequence info”

This screen displays various diagnostic data for use when calibrating the no load pressure maps for multiple reel installations, it is not available for single reel versions:

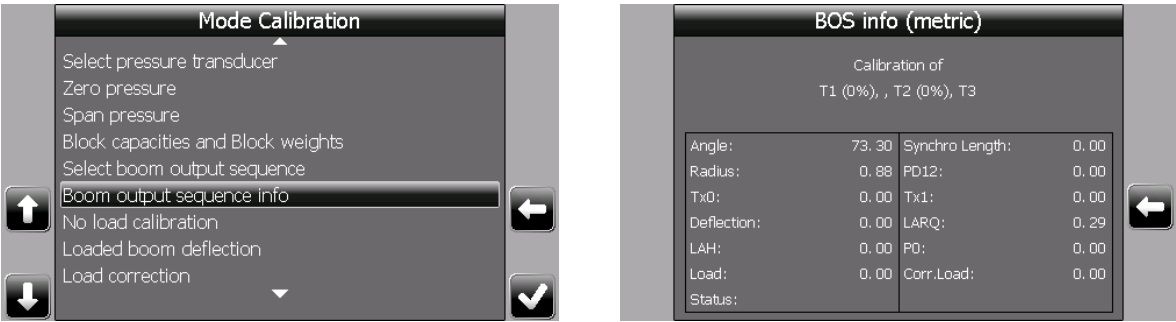

3.5 Step #16: Main boom “No Load calibration”

3 important checks before proceeding with each No Load calibration:

1. Ensure that all previous sections have been completed, in particular that all dimensions have been entered correctly and all sensors are correctly calibrated.
2. Ensure that no ‘load adjustment’ factor is applied, go to the Load adjustment calibration (section 3.8) and check that the adjustment value is 1.00. If necessary follow the instructions in this section to set the value to 1.00 for the current configuration, a test load is not required for this.
3. Ensure that no ‘load correction’ calibration points have been set, go to the Load correction calibration (section 6) and check that the next point offered is point 1, if necessary follow the instructions at the end of section 7 to delete all the load correction points for the current configuration.

The No load calibration procedure must be carried out for each of the Boom Mode configurations to record the empty boom weight. For example a separate no-load calibration needs to be done for main boom with the manual section in, and the manual section out.

For machines with more than one length sensor where multiple no load calibrations are done the system will continue to monitor the temporarily non-telescoping section(s) to ensure it is not moved. If a change is detected then the calibration will be suspended until the situation is corrected.

For all other configurations using the same main Boom Mode but with an attachment fitted (i.e. main boom + jib stowed, main boom + jib erected, lifting over jib, etc...) no other no load calibration is necessary. The system will calculate the load on the hook in use making allowance for the fitted attachment using the weight and center of gravity of the attachment already stored in memory.

For any given basic Boom Mode calibration it is essential that all unnecessary stowed attachments are removed from the boom to ensure correct performance. Only the main block should be rigged during a no load calibration and no jibs should be fitted or stowed, including rooster sheave assemblies. Refer to the duty list to determine the appropriate configuration for no load calibration and to the system configuration section of the Instruction manual.

The crane needs to be rigged for each of these main boom conditions and the appropriate duty needs to be selected before starting this procedure. Since this also applies to unloaded and loaded boom deflection calibrations, it is recommended to do both no-load and boom deflection calibrations while the machine is rigged on one particular condition to save time.

Notes:

1. During this procedure boom angle, boom length and pressures are displayed at various times for reference purposes on the display window.
2. The derrick motion immediately before recording a calibration point should always be up/in. If it was necessary to derrick down/out, then derrick up/in slightly before recording the calibration point. When telescoping in or out it is not necessary to derrick up/in, unless the crane has had to be derricked down/out during telescoping for some other reason.
3. Ensure that the crane chassis is level for all no load, boom deflection, and load correction calibrations.

Start this procedure with the boom fully retracted.

Use “↑” or “↓” to choose “No load calibration” and press “✓” to enter.

If the selected configuration has been calibrated previously the system will prompt for a new calibration or give the option to escape:

Warning: if you press “X”, the previous calibration will be lost.

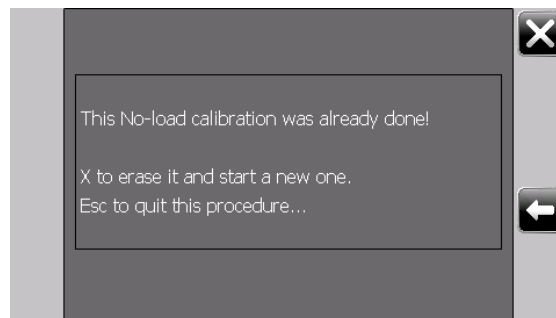

Press “X” to delete the existing calibration and go to the next screen or “←” to escape.

If this is the first calibration for this duty the display will show:

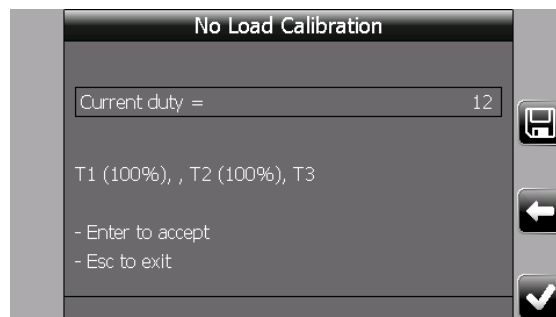

Where ‘12’ in this example is the current selected duty number. This must correspond with the current crane configuration, if incorrect use “←” to exit the calibration mode and set the correct configuration in the normal working mode. Additional information regarding the current boom output sequence is displayed if relevant.

After pressing “✓” to accept the duty to be calibrated the display shows:

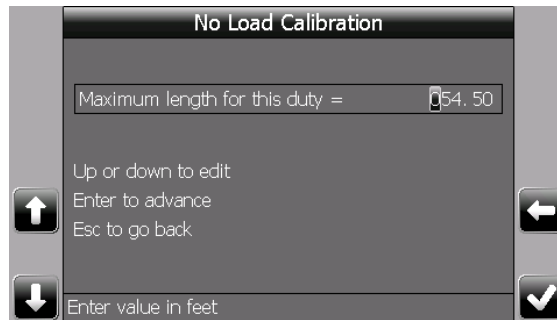

For single reel installations: **xxx.xx.** is the maximum working main boom length for this duty as measured by the extension sensor. This value is usually to the top of the last telescoping section or manual section and does not include extension fly jibs etc. The default value will be dimension CL2 or CL2MR, press “✓” repeatedly to accept this value. If the boom is to be used at a maximum or fixed length other than the default use “↑” or “↓” to edit this number to the required value. Once the last number is entered press “save” to confirm the value and move to the next step.

Special case: For booms with two telescoping ranges eg mode A with top section pinned closed and mode B with top section included in telescoping, the system default value must be over ridden when calibrating the longer boom range (mode B in this example).

For multiple reel installations: **xxx.xx.** is the difference between the retracted and extended lengths for the boom sections to be telescoped, for the previous example it is the total extension length for sections 3,4 and 5 combined.

Setting the number of length steps:

The display now shows:

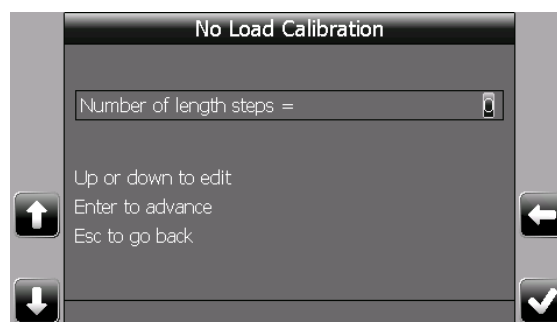

The number of length steps represents the number of different boom lengths that will be used during this calibration process, the number of points selected will directly affect the calibration time and eventual system performance. More points mean a longer calibration sequence but with improved performance. Select the number of points from the following table but note that these figures are only intended as a guide and can be

set as required (up to a maximum of 7) to enable calibration lengths to coincide with rated boom lengths. This number of points includes the shortest and longest lengths for the duty, which are mandatory.

Telescopic band to be calibrated	Minimum of points
None	2 (minimum)
Up to 6m (20ft)	3
6-10m (20-30ft)	4
10-14m (30-45ft)	5
14-18m (45-60ft)	6
Over 18m (60ft)	7 (maximum)

Use “↑” or “↓” to edit this number and press “**save**” to confirm the value and move to the next step.

If more than two lengths have been entered the display now shows:

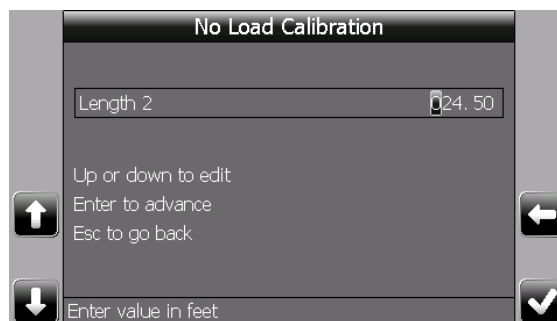

Where **length 2** is the second calibration length to be specified.

The first and last lengths will automatically be set to the minimum and maximum values specified for calibration and other calibration lengths will default to evenly distributed lengths calculated by the system.

Use “↑” or “↓” to change the default value of **length 2** if required, then press “**save**” to confirm the value and move to the next step.

Specified lengths should coincide with rated boom lengths where possible although not all rated boom lengths need to be specified. Specified lengths must include lengths at which the boom telescoping sequence changes. Where no intermediate boom lengths are shown in the crane capacity chart, use the default lengths chosen by the system.

Enter the remaining lengths as prompted ensuring that each new calibration length is larger than the preceding one and less than the maximum length.

Setting the number of angle steps for each calibration length:

When the last calibration length has been entered the display shows:

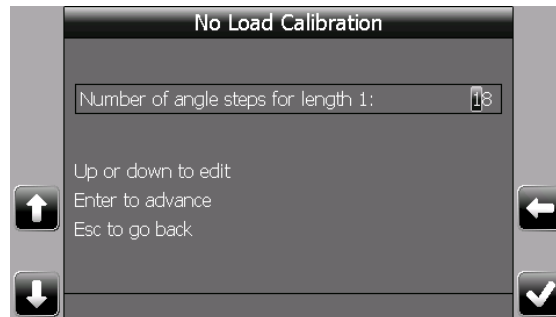

Number of angle steps for Length 1 = **xx**

Where **xx** is the number of angle steps to calibrate for length 1, length 1 represents the fully retracted boom. The number of angle steps must be between 3 (min) and 18 (max). The more points used the greater the accuracy but the longer the calibration time. It is suggested that points at 5 degree intervals will give an acceptable result. Hence for example if the maximum angle is 80 degrees and minimum is 20 degrees then 13 points should be used.

Use “↑” or “↓” to set **xx** to the required number of angle steps for calibration length 1 then press “**save**” to accept.

Enter the number of angle calibration points for each length step in turn as prompted.

Setting the maximum boom angle:

The display will show:

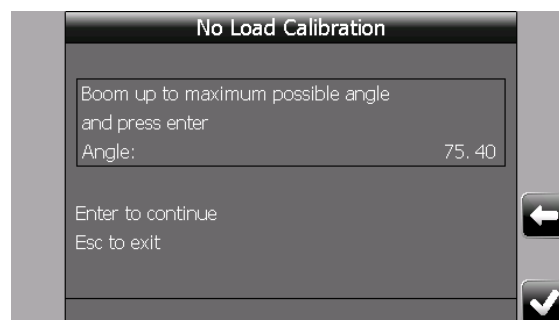

Derrick the boom up to the maximum possible angle, that is, with the boom hoist cylinder **almost** fully extended, just avoiding the maximum boom angle stops and press “✓” when done.

Setting the minimum boom angle for each calibration length:

The display will show:

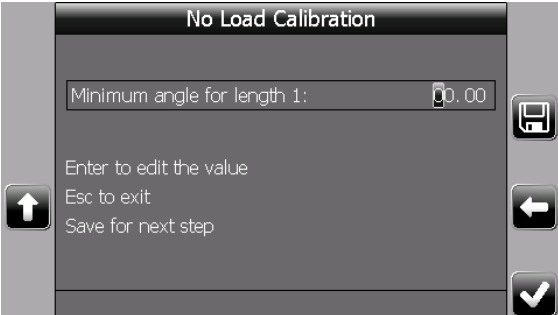

Minimum angle for length 1 = **xx.xx**

Where **xx.xx** is the lowest working angle in degrees for length 1. Check the load chart and determine the lowest rated angle for each of the boom lengths you have previously entered; i.e. length 1, length 2, etc. and enter separate minimum working angles for each calibration length as prompted. When complete the display will show:

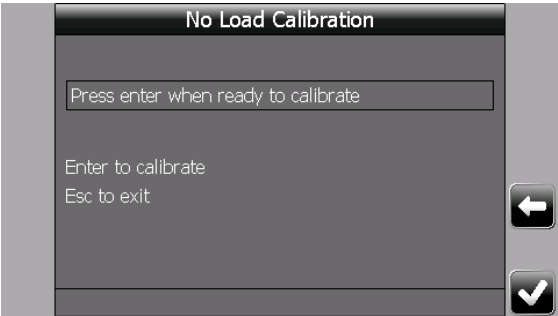

Recording the 'no load' pressure map:

The i4500 has now been programmed with all preset points and is ready to calibrate.

The following procedure to record unloaded boom weight pressures should be carried out with the hook block suspended at all times.

Remember the i4500 is not yet fully functional; be careful not to exceed the operating parameters of the crane particularly at long boom lengths and low angles.

When ready press "✓".

The display will show:

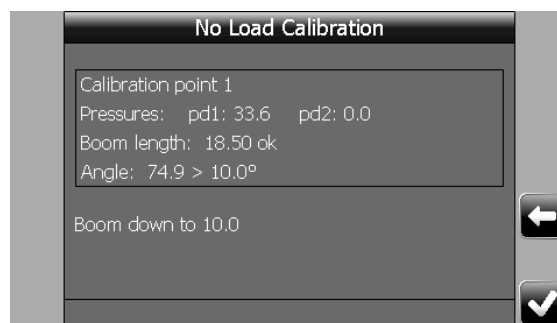

pd1: is the current bore side pressure

pd2: is the current rod side pressure

Boom length: will show the current length followed by the target length for this calibration point or **ok** if at the correct length.

Angle: will show the current angle followed by the target angle for this calibration point or **ok** if at the correct angle.

If one or both values needs to be adjusted, a message will be displayed suggesting the action to take (tele in, tele out, boom up, boom down) together with the relevant target value. The system will prompt for the length to be set first then the angle, **remember to make boom up the last angle movement.**

When both length and angle are correct the display will change to:

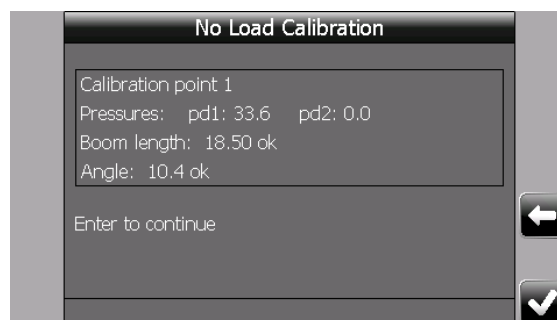

Allow the crane to settle (monitor the live angle and pressure readings shown here) and once the readings are stable press “✓” to record the calibration point. Repeat this procedure for each calibration point in turn as prompted starting with all angles for length 1 then length 2 etc. until all lengths and angles have been recorded. At the end of each length sequence the system will pause to automatically save the calibration data up to this point. If the calibration is exited at this stage then the system will display the following screen when the no load calibration is reselected, allowing the procedure to continue from the same point without the need to redo the completed section.

Note the incomplete calibration will be lost if the duty is changed before returning to the no load calibration procedure.

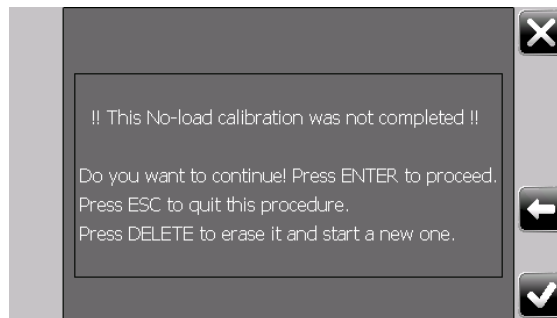

When the final calibration point is accepted the i4500 will automatically save the data and display the following confirmation screen:

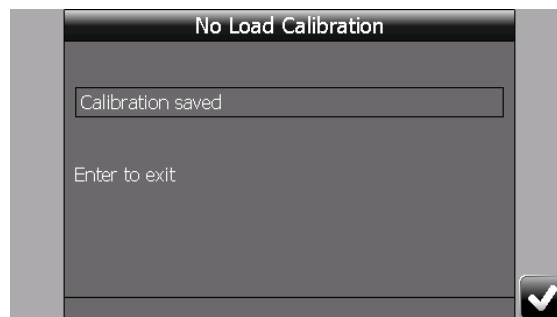

Press “✓” to return to the main calibration menu.

To exit the no load calibration at any point prior to completion press “←” then confirm the action by pressing “✓”.

Before proceeding with additional calibration work check the overall performance by moving the unloaded hook around the working envelope; i.e. high/low angles and long/short boom. If an unacceptable variation in displayed hook weight is seen then check geometric dimensions entered earlier, re-calibrate the no load pressure map using more calibration angles and lengths, or proceed to add load adjustment, offset and/or correction calibrations. Always check results at this stage after booming up. Boom down can be checked after the full calibration is completed.

For the definition of required accuracy refer to national and international standards applicable where the crane is in use eg SAE J159 in USA or EN13000 in Europe.

3.6 Step #17: Main boom “Unloaded boom deflection”

This procedure is used to add an allowance into the calculation of the hook radius to compensate for main boom and/or chassis deflection due to the self weight of the machine. A separate calibration is available for each crane configuration that also has an individual no load calibration, this includes each individual telescoping sequence for multi-reel applications but is not used for configurations with boom attachments (refer to Section 3.11).

A no load calibration should be completed before continuing with this procedure. This procedure should only be used with machine configurations on outriggers or on crawlers.

This calibration is done with an empty hook which should be freely suspended at all times.

Ensure the current duty selection matches the actual crane configuration to be calibrated.

Select the required boom telescoping sequence if relevant, see manual section 3.4.

- 1) Use “↑” or “↓” to highlight “Unloaded boom deflection” and press “✓” to enter.

The display will show the current boom length and a target boom length for calibration plus additional information about the telescoping sequence if relevant. The target value should be ignored for this calibration if working with multi-reel or dual telescoping mode booms.

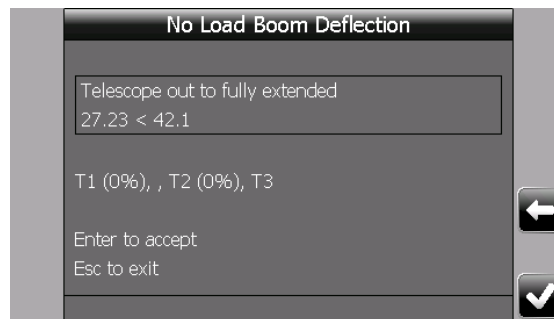

With the hook block suspended, telescope the boom out to fully extended for the boom mode and telescoping sequence selected. This will generally be shorter than the target indicated when working with multi-reel applications or longer than the target indicated when calibrating the larger telescoping range when working with dual mode telescoping booms.

Warning: Be sure to check that the hook block does not foul the boom tip and that the boom is at a high enough angle to safely permit maximum extension.

- When the boom is at the desired extension, press “✓” to accept, the display will change to show the current boom angle followed by a target boom angle for calibration, the default target of 60° is for guidance and can be ignored if necessary:

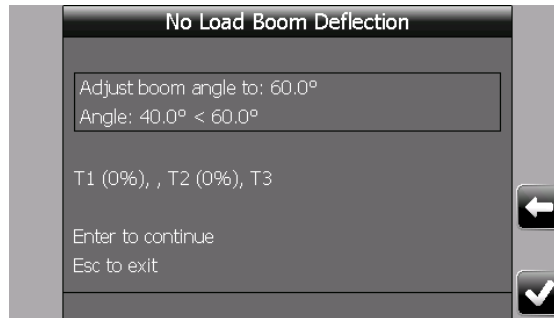

- Adjust the boom angle to the target angle, when the boom is at the correct angle for calibration the display will change to show, if a different angle is necessary press “✓” to move directly to step 4:

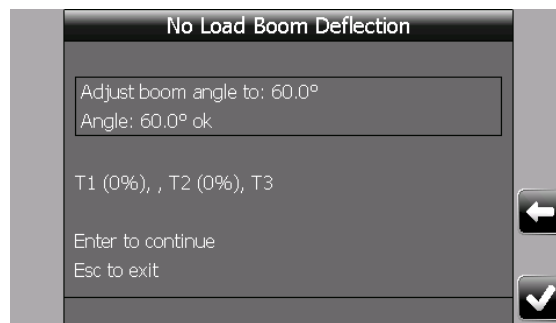

- Press “✓”, the display will change to show:

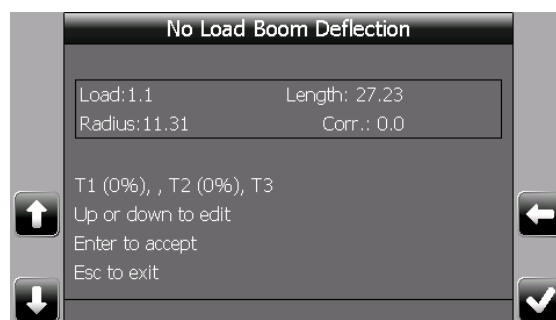

- Accurately measure the actual radius of the suspended hook from the centre line of slew of the machine.
- Use “↑” or “↓” to adjust the Corr.: x.x value until the displayed radius equals the measured radius, note that the indicated radius should normally be increased, not decreased. Press “✓” to accept, the display will change to show:

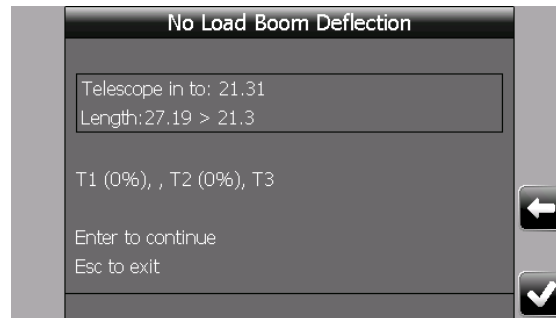

7. Telescope in to between $1/3^{\text{rd}}$ and $1/2$ of the extension range being calibrated, remember to ignore the target value if working with multi-reel or dual telescoping mode booms.
8. When the boom is at the desired extension, press “✓” to accept, the display will change to show the current boom angle followed by a target boom angle for calibration.
9. Accurately measure the actual radius of the suspended hook and adjust the new correction value until the displayed radius equals the measured radius. Press “✓” to accept.
10. Press “←” to return to the main calibration menu.

3.7 Step #18: Main boom “Loaded boom deflection”

This procedure is used to add an allowance into the calculation of the hook radius to compensate for main boom and/or chassis deflection due to a suspended load. A separate calibration is available for each crane configuration that also has an individual no load calibration, this includes each individual telescoping sequence for multi-reel applications but is not used for configurations with boom attachments (refer to Section 3.11).

A no load calibration should be completed before continuing with this procedure. This procedure should only be used with machine configurations on outriggers or on crawlers.

A known test weight is required to carry out this calibration, the weight should be between 50% and 90% of the SWL for the configuration being calibrated and should be based on the SWL with a fully extended boom at approximately 60° boom angle. The calculated test load should normally include the weight of the hook block and any slings, shackles etc. that are used.

Ensure the current duty selection matches the actual crane configuration to be calibrated.

2) Use “↑” or “↓” to highlight “Loaded boom deflection” and press “✓” to enter. The display will show the current boom length and a target boom length for calibration plus additional information about the telescoping sequence if relevant. The target value should be ignored for this calibration if working with dual telescoping mode booms.

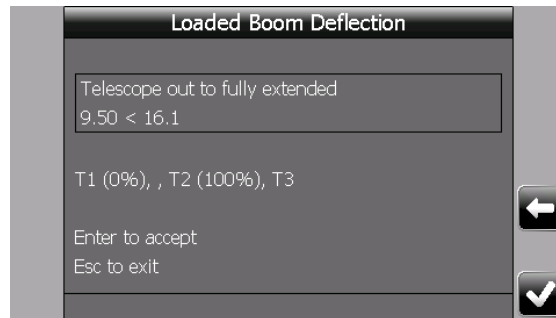

With the hook block suspended, telescope the boom out to fully extended for the boom mode and telescoping sequence selected, for dual mode booms this will be longer than the target indicated when calibrating the larger telescoping range.

Warning: Be sure to check that the hook block does not foul the boom tip and that the boom is at a high enough angle to safely permit maximum extension.

When the boom is at the desired extension the display will change to show:

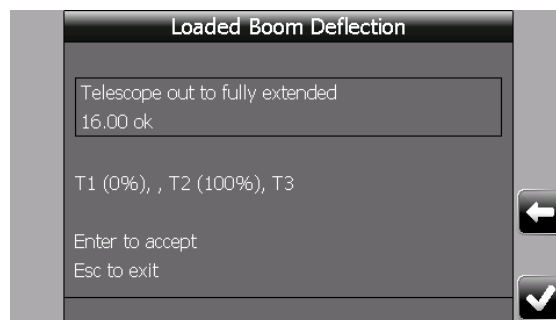

- 2) Press "✓", the display will change to show the current boom angle followed by a target boom angle for calibration, normally 60°.

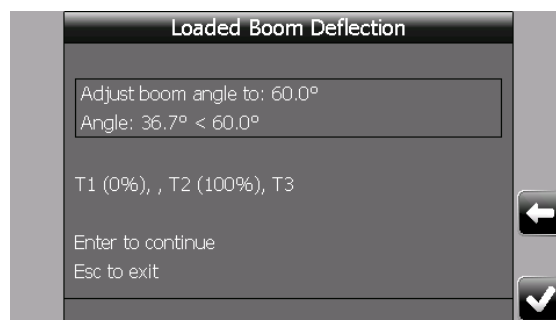

Adjust the boom angle to the target angle, when the boom is at the correct angle for calibration the display will change to show:

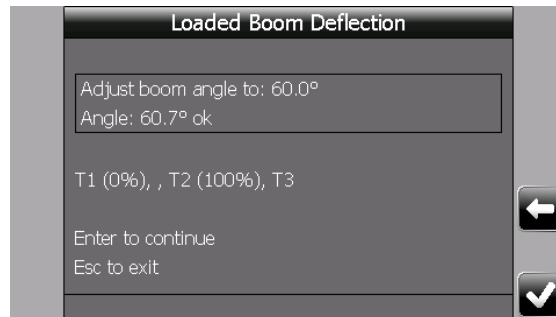

3) Press "✓", the display will change to show one of these screens:

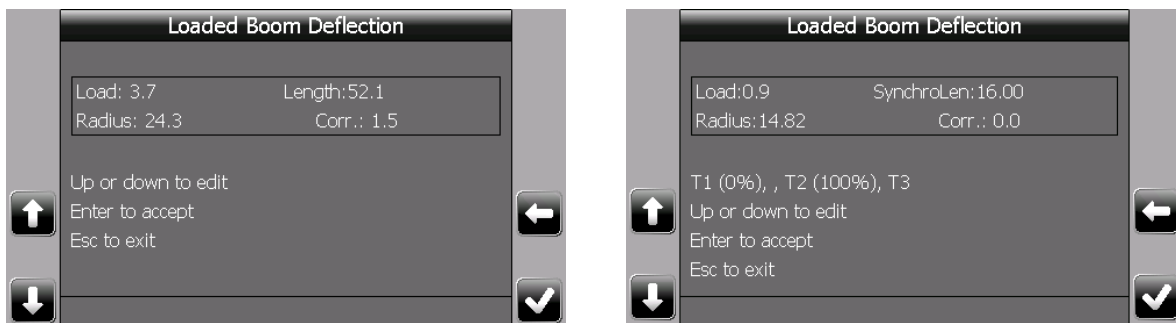

Carefully lift the test load until it is just clear of the ground. Accurately measure the actual radius of the suspended load from the centre line of slew of the machine.

- 4) Use "↑" or "↓" to adjust the Corr.: x.x value until the displayed radius equals the measured radius, note that the indicated radius should normally be increased, not decreased. Press "✓" to accept the change, the system will confirm the calibration is saved.
- 5) Press "←" to return to the main calibration menu.

Carefully set the test load on the ground.

3.8 Step #19: Main boom “Load adjustment”

This feature is optional and can be omitted if the displayed load is judged acceptable, it is normally used in tandem with section 3.9 ‘load offset’. A separate calibration is available for each crane configuration that also has an individual no load calibration, this includes each individual telescoping sequence for multi-reel applications but is not used for configurations with boom attachments(refer to Section 3.12).

It is used to increase the accuracy of the load on hook indication. This will compensate for minor geometric errors that may come from crane manufacturing tolerances or from the method used to take the dimensions, weights and centre of gravity locations of attachments.

The hook weight should not be used alone to judge the load reading performance. This should be checked using at least 3 different weights, the hook block, 25% SWL, and a load greater than 50% SWL. The results of these checks should be used to determine whether “load adjustment”, “load offset” or a combination of both should be used to improve performance.

“Load adjustment” should only be used if the load reading indicates a constant percentage of load error for the complete operating range, it allows for a positive or negative percentage value adjustment to be applied to the displayed load. If the error is variable then verify all data entries required in the dimension and calibration data section.

It is recommended that this procedure is done with the machine on outriggers or crawlers.

A known test load is needed to perform this calibration and should be between 50% and 90% of SWL for the configuration to be calibrated. This SWL should be based on the capacity with a boom angle of approximately 60° and with the boom fully retracted for the boom mode selected.

The calculated test load should normally include the weight of the hook block and any slings, shackles etc. that are used.

Ensure the current duty selection matches the actual crane configuration to be calibrated.

- 1) Use “↑” or “↓” to highlight “Load adjustment” and press “✓” to enter.

The display will change to show:

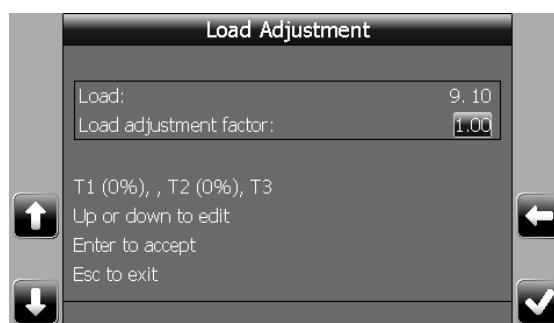

Where **Load:** represents the suspended load reading and **1.00** represents the adjustment factor (a value of 1.00 signifies that there is no applied adjustment). The main boom must be completely retracted for the mode selected and with an angle of approximately 60°. When positioning the machine remember to make the last derrick motion boom up. Carefully lift the test load until it is just clear of the ground.

- 2) Use “↑” or “↓” to modify the load adjustment factor until the displayed load is equal to the test load. Press “✓” to accept the change, the system will confirm the calibration is saved.

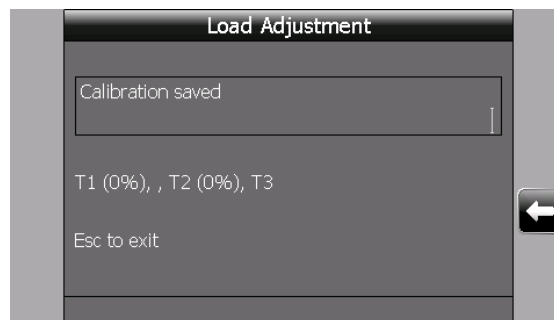

- 3) Press “←” to return to the main calibration menu.

Carefully set the test load on the ground.

To clear the effect of load adjustment, enter the screen above and adjust the factor to read 1.00 then accept the change as before. This should always be done before commencing a no load calibration, see section 3.5.

3.9 Step #20: Main boom “Load offset”

This feature is optional and can be omitted if the displayed load is judged acceptable, it is normally used in tandem with section 3.8 ‘load adjust’. A separate calibration is available for each crane configuration that also has an individual no load calibration, this includes each individual telescoping sequence for multi-reel applications but is not used for configurations with boom attachments(refer to Section 3.13).

It is used to increase the accuracy of the load on hook indication. This will compensate for minor geometric errors that may come from crane manufacturing tolerances or from the method used to take the dimensions, weights and centre of gravity locations of attachments.

Use the load checks performed in section 3.8 to establish if a “load offset” is required.

“Load offset” should only be used if the load reading indicates a constant fixed load error for the complete operating range, it allows for a positive or negative fixed value offset to be applied to the displayed load. If the error is variable then verify all data entries required in the dimension and calibration data section.

It is recommended that this procedure is done with the machine on outriggers or crawlers.

A known test load is needed to perform this calibration and should be between 50% and 90% of SWL for the configuration to be calibrated. These SWL's should be based on the capacity with a boom angle of approximately 60° and with the boom fully retracted for the boom mode selected.

The calculated test loads should normally include the weight of the hook block and any slings, shackles etc. that are used.

Ensure the current duty selection matches the actual crane configuration being used for the calibration.

- 1) Use “↑” or “↓” to highlight “load offset” and press “✓” to enter.

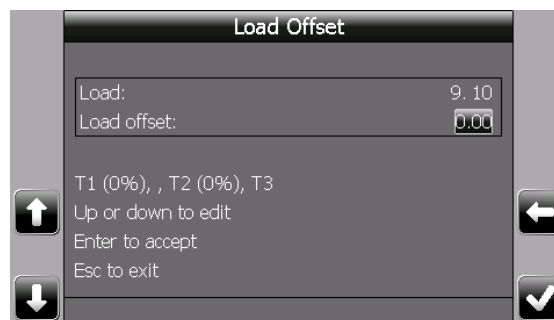

Where **Load:** represents the suspended load reading and **0.00** represents the offset factor (a value of 0.00 signifies that there is no applied offset). The main boom must be completely retracted for the mode selected and with an angle of approximately 60°. When positioning the machine remember to make the last derrick motion boom up. Carefully lift the test load until it is just clear of the ground.

- 2) Use “↑” or “↓” to modify the load offset factor until the displayed load is equal to the test load and press “✓” to accept the change, the system will confirm the calibration is saved.

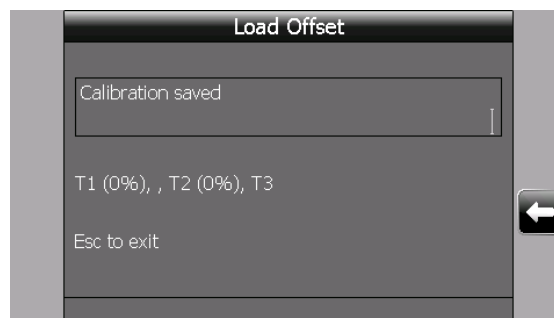

- 3) Press “←” to return to the main calibration menu.
Carefully set the test load on the ground.

In some rare instances where the above adjustments do not provide acceptable results it may be necessary to use a more sophisticated method of load corrections. See section 6 for details but be sure to take notice of the warnings before proceeding.

3.10 Step #21: Attachment “Jib deflection”

This procedure is only available if jib duties are available and is optional depending on the accuracy of the radius indication of the jib, it is used to add an allowance into the calculation of the jib hook radius to compensate for jib deflection both with and without a suspended load. A separate calibration is available for each and every jib attachment.

Jib deflection is an additional factor to the main boom deflection and the relevant main boom deflection calibration should be completed before attempting this procedure.

A known test weight is required to carry out this calibration, the weight should be between 50% and 90% of the SWL for the configuration being calibrated and should be based on the SWL with the boom at the calibration angle chosen below, this angle is normally approximately 60° but any value can be chosen if this proves unsuitable. The calculated test load should normally include the weight of the hook block and any slings, shackles etc. that are used.

Ensure the current duty selection matches the actual crane configuration to be calibrated, this duty must be a jib duty.

- 1) Use “↑” or “↓” to highlight “Jib Deflection” and press “✓” to enter. The display will show the current boom angle followed by a target boom angle of 60° for calibration.

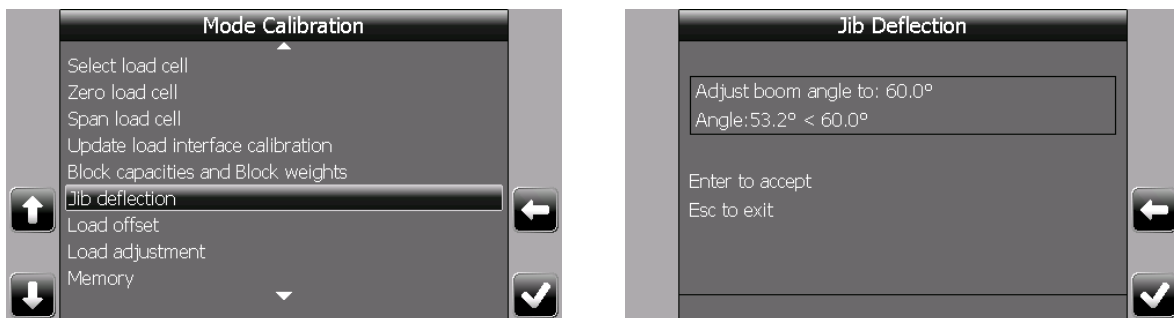

- 2) Adjust the boom angle to the target angle, when the boom is at the correct angle for calibration, the display will change to show OK. Note: if 60° is unsuitable eg is below the minimum rated angle for the duty then set the boom to a suitable alternative and ignore the target angle.

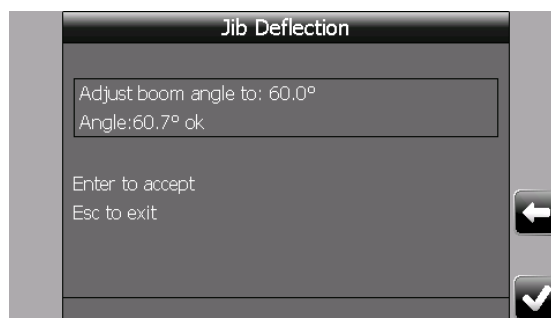

- 3) Press “✓”, the display will change to show the first calibration screen.

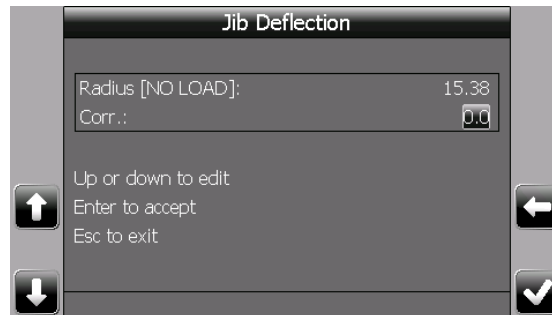

- 4) With just the hook suspended, accurately measure the actual radius of the hook from the centre line of slew of the machine.
- 5) Use “↑” or “↓” to adjust the “Corr” value until the displayed radius equals the measured radius. Note: a positive value for “Corr” will increase the indicated radius. Press “✓” to accept the change and move to the second calibration screen.

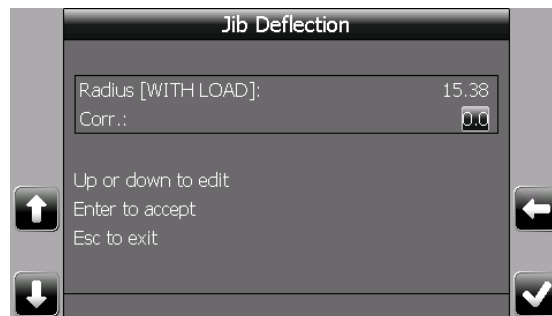

- 6) Carefully lift the test load until it is just clear of the ground. Accurately measure the actual radius of the suspended load from the centre line of slew of the machine.
- 7) Use “↑” or “↓” to adjust the “Corr” value until the displayed radius equals the measured radius. Press “✓” to accept the change, the system will save the calibration, press “←” return to the main calibration menu.

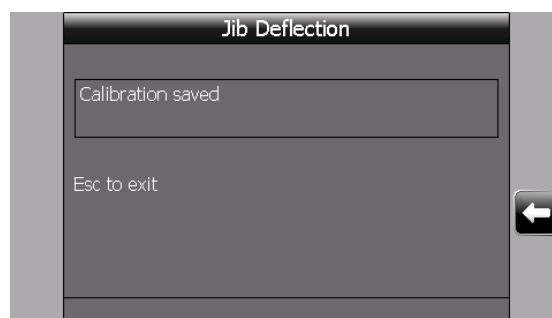

- 8) Carefully set the test load on the ground.

3.11 Step #22: Attachment “Load adjustment”

This feature is optional and can be omitted if the displayed load is judged acceptable, it is normally used in tandem with section 3.13 ‘load offset’. A separate load adjustment calibration is available for each and every jib attachment and is used to improve the accuracy of the load on hook indication.

The hook weight should not be used alone to judge the load reading performance. This should be checked using at least 3 different weights, the hook block, 25% SWL, and a load greater than 50% SWL. The results of these checks should be used to determine whether “load adjustment”, “load offset” or a combination of both should be used to improve performance.

“Load adjustment” should only be used if the load reading indicates a constant percentage load error for the complete operating range, it allows for a positive or negative percentage value adjustment to be applied to the displayed load. If the error is variable then verify all data entries required in the dimensions area of the chart file are correct before proceeding.

It is recommended that this procedure is done with the machine on outriggers or crawlers.

A known test load is needed to perform this calibration and should be between 50% and 90% of SWL for the configuration to be calibrated. This SWL should be based on the capacity with a boom angle of approximately 60°.

The calculated test load should normally include the weight of the hook block and any slings, shackles etc. that are used.

Ensure the current duty selection matches the actual crane configuration to be calibrated.

- 1) Use “↑” or “↓” to highlight “Load adjustment” and press “✓” to enter. The display will change to show:

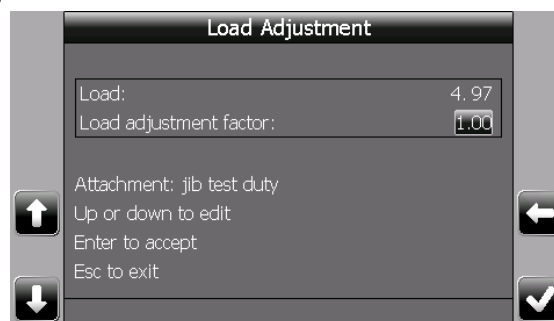

Where **Load:** represents the suspended load reading and **1.00** represents the adjustment factor (a value of 1.00 signifies that there is no applied adjustment). The main boom should be at an angle of approximately 60°. When positioning the machine

remember to make the last derrick motion boom up. Carefully lift the test load just clear of the ground.

- 2) Use “↑” or “↓” to modify the load adjustment factor until the displayed load is equal to the test load. Press “✓” to accept the change, the system will confirm the calibration is saved.

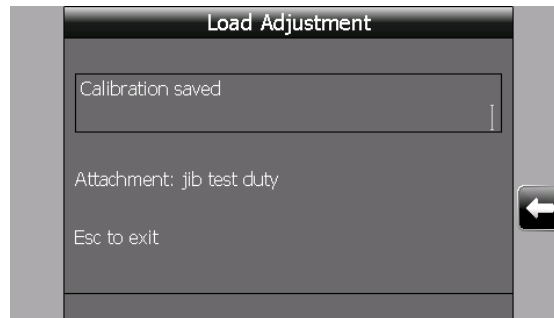

- 3) Press “←” to return to the main calibration menu.
Carefully set the test load on the ground.

3.12 Step #23: Attachment “Load offset”

This feature is optional and can be omitted if the displayed load is judged acceptable, it is normally used in tandem with section 3.12 ‘load adjustment’. A separate load offset calibration is available for each and every jib attachment and is used to improve the accuracy of the load on hook indication.

Use the load checks performed in section 3.12 to establish if a “load offset” is required.

“Load offset” should only be used if the load reading indicates a constant fixed load error for the complete operating range, it allows for a positive or negative fixed value offset to be applied to the displayed load. If the error is variable then verify all data entries required in the dimensions area of the chart file are correct before proceeding.

It is recommended that this procedure is done with the machine on outriggers or crawlers.

A known test load is needed to perform this calibration and should be between 50% and 90% of SWL for the configuration to be calibrated. This SWL should be based on the capacity with a boom angle of approximately 60°.

The calculated test load should normally include the weight of the hook block and any slings, shackles etc. that are used.

Ensure the current duty selection matches the actual crane configuration to be calibrated.

- 1) Use “↑” or “↓” to highlight “Load offset” and press “✓” to enter.

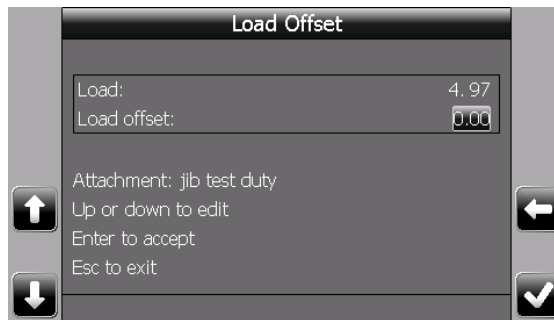

Where **Load:** represents the suspended load reading and **0.00** represents the offset factor (a value of 0.00 signifies that there is no applied offset). The main boom should be at an angle of approximately 60°. When positioning the machine remember to make the last derrick motion boom up. Carefully lift the test load until it is just clear of the ground.

- 2) Use “↑” or “↓” to modify the load offset factor until the displayed load is equal to the test load and press “✓” to accept the change, the system will confirm the calibration is saved.

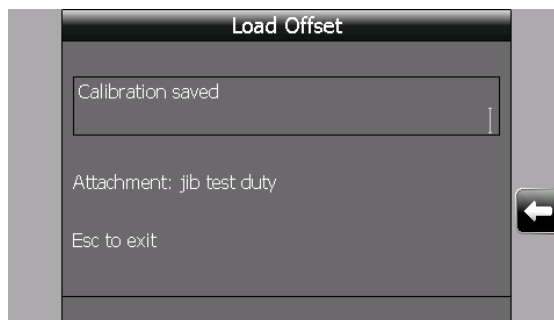

- 3) Press “←” to return to the main calibration menu. Carefully set the test load on the ground.

3.13 Step #24: “Friction compensation”

This procedure should not be used except under guidance from Rayco Wylie Systems with the exception of down friction.

All of the factors in this menu, with the exception of down friction, are used to compensate for static pressure decay over time but significant testing and analysis may be required before any of these default values are modified. The default screens are shown below for reference:

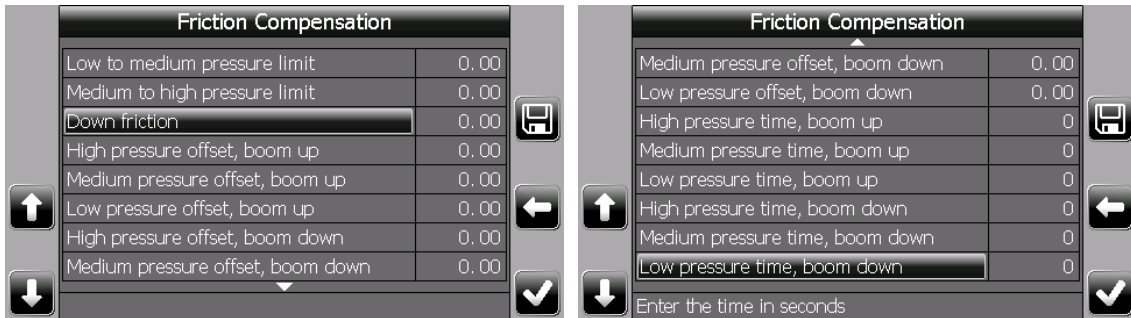

Boom down friction compensation should only be done once the no load calibration and various deflection calibrations have been completed. Only one boom down friction compensation value is available and it will affect all configurations of the machine.

The down friction factor is best established by trial and error :

- 1) Use “↑” or “↓” to highlight “friction compensation” and press “✓” to enter.
- 2) Scroll down to “down friction” and press “✓” to highlight the value for editing, 0.00 indicates that no friction compensation is applied. To begin with, increase the default value from 0.00 to 0.10 and press “✓” to confirm.
- 3) Press “save” to record the change.
- 4) Press “←” to exit the calibration mode and retest the boom down performance to establish the effect, return to the down friction calibration and modify as required.

3.14 Step #25: “Transfer” Calibration backup

A copy of the calibration file can be made at any time after completing a calibration step and should be made once the final calibration is completed. **Note** a USB memory stick must be connected to connector ‘B’ of the i4500 display unit using a Deutsch to USB converter lead (RaycoWylie part no. 33V0414) before proceeding. The USB memory stick must be formatted to FAT32 format.

- 1) Use “↑” or “↓” to highlight “transfer” and press “✓” to enter.

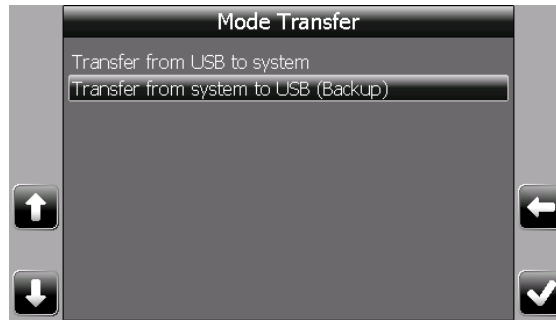

- 2) Select “transfer from system to USB (backup)” ” and press “✓”



- 3) Select “calibration -> USB stick” ” and press “✓”, a copy of the calibration information will be created in a file called “cranename_000000.cal” located in the root folder of the USB memory stick. If a file of this name already exists ie a previous backup has been made then the new file will become “cranename_000000-1.cal” etc.

The final completed calibration file should be renamed:

“cranename_serialnumber_date_tech.cal” where serialnumber is the serial number of the i4500 system, the date is the date the calibration file is completed/downloaded and tech is the initials of the calibrating technician.

For early operating systems prior to rev sc122...v0200, some configuration specific calibration data may be stored in the load chart file and, for these versions only, it is recommended to also make a backup copy of this second file:

Select “load chart -> USB stick” ” and press “✓”, a copy of the load chart file will be created in a file called “cranename”, this file will overwrite any existing file of the same name and will not have a file extension included. This file should be renamed **“cranename_serialnumber_date_tech.cf”** and stored as a matching pair with the cal file above. A copy of these files should be sent to Rayco Wylie for archive purposes.

3.15 “Transfer” restoring calibration and load chart files

Warning: This procedure will overwrite the existing data in the i4500 system and the existing data will be lost. It is advisable to archive copies of the existing data using the procedure in section 3.15 as a precaution before continuing. If in doubt consult Rayco Wylie.

A copy of the calibration and/or load chart files can be restored to the i4500 system at any time. **Note** a USB memory stick must be connected to connector ‘B’ of the i4500 display unit using a Deutsch to USB converter lead (RaycoWylie part no. 33V0414) before proceeding. The USB memory stick must be formatted to FAT32 format. Ensure the file required to be restored is saved in the root folder of the USB stick.

Navigate through the calibration menu using “↑” or “↓” to highlight “transfer” and press “✓” to enter.

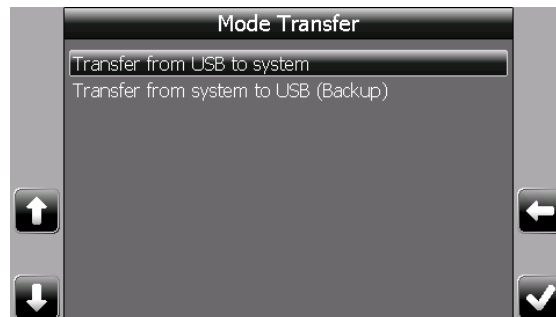

Select “transfer from USB to system” ” and press “✓”



To restore a load chart file select “usb stick -> Load chart” ” and press “✓” or to restore a calibration file select “usb stick -> Calibration” ” and press “✓”,



A list of files will be displayed, either “**xxxx.cf**” or “**xxxx.cal**” depending on the choice above. Note that only files located in the root folder of the USB stick will be displayed. Select the relevant file from the list displayed and press “✓”, the selected file will be copied to the i4500 system and will replace any existing data. Once done, it is advisable to reboot the system (power off and on again) and reselect a valid configuration, **do not** accept the existing default duty presented on start up.

3.16 “Memory”

Warning: Initialising memory A will delete all the information stored in the calibration memory, be sure you have made a backup copy of the calibration file before using this option – **if in doubt, don’t!**

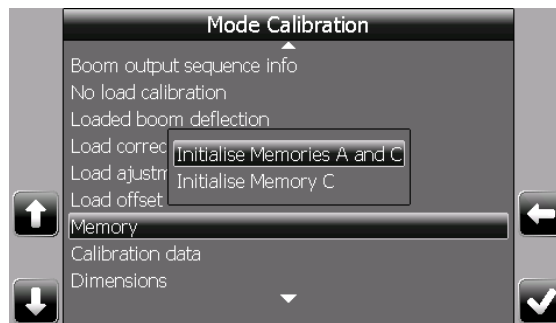

initialize memories A and C

Select this option to re-initialize the system memory, a warning screen will be displayed to ask for confirmation, if confirmed all calibration data will be deleted.

initialize memory C

Select this option to re-initialize the memory for the current configuration, only data related to the current operator settings will be deleted ie duty number, parts of line settings etc. Reset the duty configuration immediately after initializing memory C.

4 OPTIONS

4.1 “Limits setting” parameters

This menu contains the approach warning gaps for all the limits that can be set by the operator in normal mode. This menu is replaced by “rotation data” if a slew encoder is fitted.

After selecting “limits setting” from the main calibration menu the screen will show:

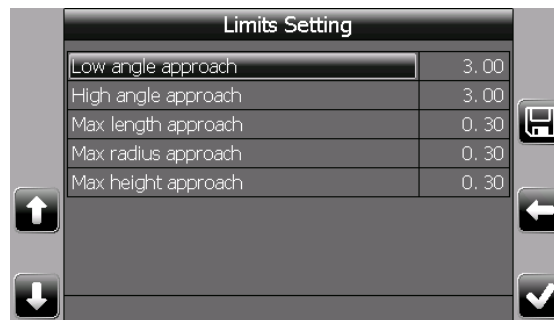

Set the approach gap for each limit in turn, angle approach gaps are in degrees, length, radius and height gaps are set using the calibration units. Remember to press “save” once all the data is entered.

4.2 “Special calibration”

This section will contain calibration settings for special features if enabled and will be described in a separate addendum to this manual.

4.3 “Users ID” Setting user pass codes for the data logger

This feature is only used if the data logger feature is fitted to the system and password protection is set to ON. It is a list of password numbers used to log into the i4500 on startup and can be used in conjunction with the Rayco Wylie data logger software for PC to record individual user data for each working session of the machine. Where this feature is not used the default login number is “99999”.

Navigate through the calibration menu using “↑” or “↓” to highlight “users id” and press “✓” to enter.

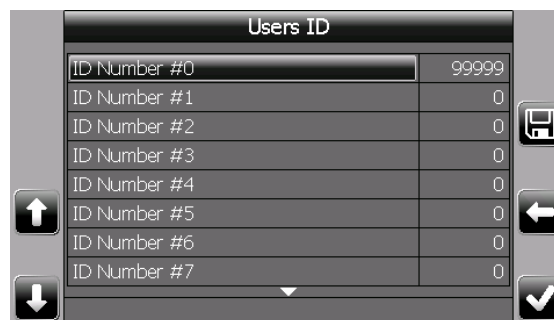

Scroll down to the first “0” entry and press “✓” to highlight the value for editing, (0 indicates an unset value and is not a valid login number) change the 5 digit number to the required code and press “save” to accept the change, press “←” to return to the main calibration menu. There are 100 different code numbers available to set including the default value.

To delete a number, change it to “00000” which is not a valid id number.

Note: It is recommended that the default value of “99999” is retained and new entries made from position 2 onward but if the default value is changed remember to safely record the new value. The i4500 system must have a valid number entered before it will go to the normal working screen if password protection is set to ON.

4.4 “Rotation data”

This feature is only available if the range limiting feature is fitted to the system or a sensor is used to monitor the slew position of the crane for duty selection.

Navigate through the calibration menu using “↑” or “↓” to highlight “rotation data” and press “✓” to enter.

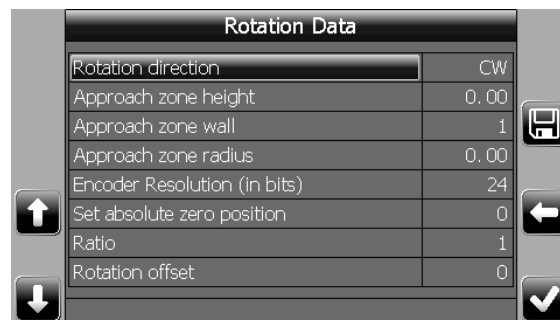

Rotation direction: set to CW (clockwise) or CCW (counter-clockwise) as required to ensure that the slew angle reading increases when the machine is slewed to the right as viewed from the operators’ position.

Approach zone height: this value represents the approach warning gap for the height limit in the units set for calibration.

Approach zone wall: this value represents the approach warning gap for the slew limit in degrees.

Approach zone radius: this value represents the approach warning gap for the radius limit in the units set for calibration.

Encoder resolution (in bits): This will be factory set and should not be changed. It represents the type of the encoder that is fitted.

Set Absolute zero position: This is used to set the zero datum point for the slew sensor.
 Note: set the ratio first before setting this zero point (see below).

Rotate the machine to the zero datum point, normally centred over the front of the machine, and press “✓” to set the slew angle reading to zero and permanently store this point.

Ratio: This represents the number of turns that the encoder rotates for a single 360° rotation of the crane.

To set this ratio automatically:

- 1) Position the crane at an identifiable slew position and check that it will be safe to rotate the machine for a full circle.
- 2) Select “**ratio**” and press “✓”, then highlight “Automatic” and press “✓” again to select.

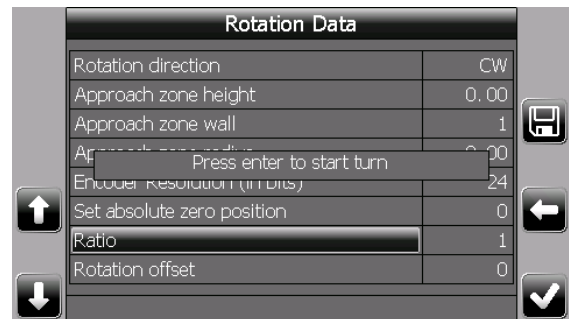
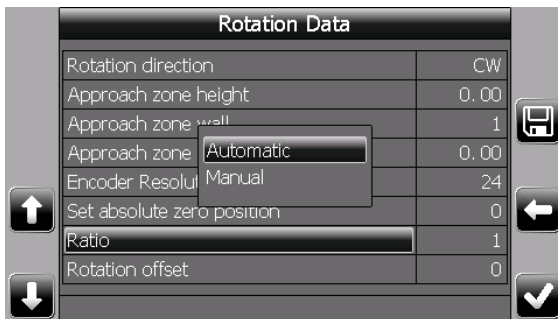

- 3) When ready to start the recording process press “✓” again and rotate the machine 360° and return to the exact start point.
- 4) When satisfied that the machine is exactly one turn from the start, press “✓” to confirm the position and press “save” to store it to memory.
- 5) Press “←” to return to the main calibration menu.

To set this ratio manually:

- 1) Select “**ratio**” and press “✓”, then highlight “Manual” and press “✓” again to select.

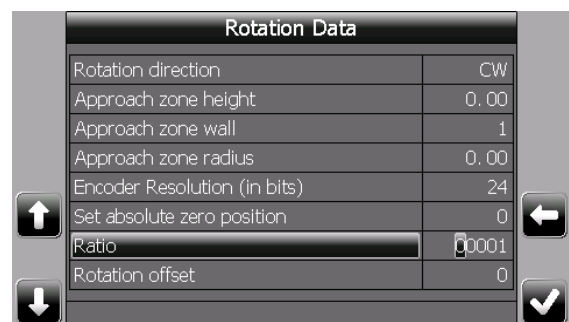
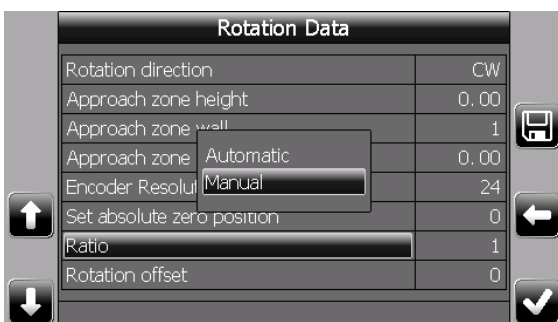

- 2) Edit the numerical value for ratio as required and press ‘save’ to store it.
- 3) Press “←” to return to the main calibration menu.

Rotation offset: This value represents an offset angle with respect to the zero datum point and is normally set to 0. For example, setting this value to 100 will mean the system will display 100 degrees when the sensor is at it's absolute zero set point.

5 AUTOMATIC LOGS

5.1 “Fault log”

The fault log screen is a diagnostic tool used to record intermittent errors detected in various parts of the system. The numbers on the right hand side of this screen represent a count of the number of individual faults detected for each component and can be useful in tracing system faults.

Navigate through the calibration menu using “↑” or “↓” to highlight “fault log” and press “✓” to enter.

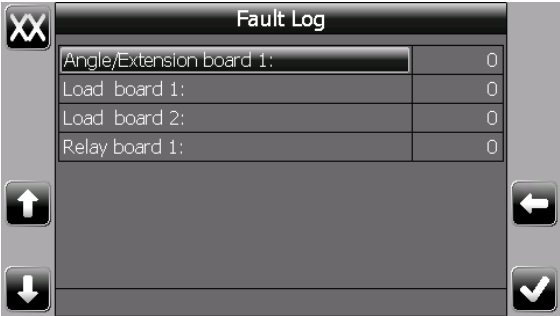

Note the fault status, press “←” to return to the main calibration menu or press “XX” to reset all the counters to zero.

5.2 “Event recorder”

The event recorder provides a summary of lifts performed in each 10% band of SWL, it also provides a count of ATB and bypass activations. **Note:** the event recorder does not replace the data logger feature as no date and times are recorded, the counters can be reset at any time and event data is not downloadable for external analysis.

Navigate through the calibration menu using “↑” or “↓” to highlight “event recorder” and press “✓” to enter.

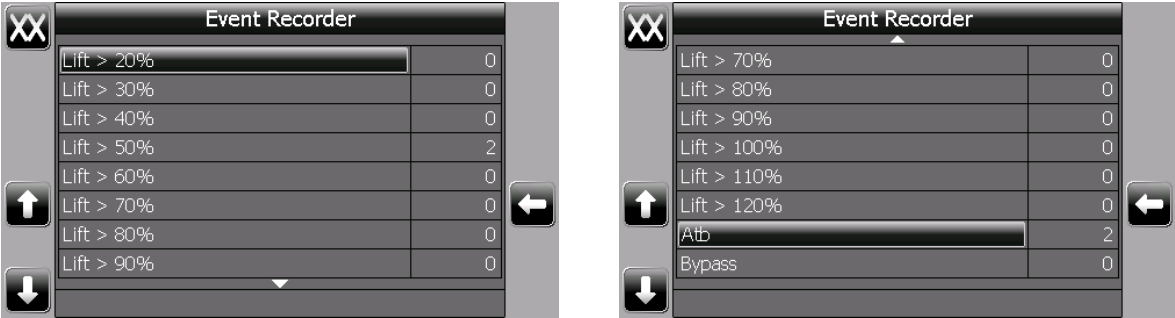

Note the event status, these sample screens show 2 lifts performed between 50 and 60% SWL and also 2 ATB alarms recorded. Press “←” to return to the main calibration menu or press “XX” to reset all the counters to zero.

6 ANNEX 1 – Calibration of Main boom “Load correction”

Warning Note : This procedure will not normally be necessary and should not be used unless under the guidance of RW technical staff. It must not be used before exhausting other, more likely, causes of load reading errors such as dimensional errors or proper no load calibration using an adequate number of calibration points.

A separate calibration is available for each crane configuration that also has an individual no load calibration, this includes each individual telescoping sequence for multi-reel applications but is not used for configurations with boom attachments (refer to Section 3.12 and 3.13).

It is used to add an allowance into the calculation of the hook load to compensate for a potential build up of minor errors in either fixed data or previous calibration data. It is recommended that this procedure is done with the machine on outriggers or crawlers.

Some inaccuracy of load indication with very small loads at high boom angles and short boom lengths is likely due to the small boom lift cylinder pressures encountered in this zone. Do not use the weight of the hook block alone to judge load indication performance, these calibrations should be done with loads in excess of 50% SWL.

If a load correction calibration is found to be necessary the minimum number of correction factor points that must be calibrated is 2, the maximum that can be calibrated is 20. The lowest boom angle used for load correction calibration must be 0 degrees or higher (ie it cannot be negative).

The following notes are intended to give general guidance only as each individual installation will be different. The full working envelope of the configuration can be divided into different zones for load correction calibration, see the following diagrams for examples.

Case 1

This shows a basic, two point calibration. These two points cannot have a common angle or boom length. A load correction factor will be applied to all boom positions whose angle and length are greater than point 1 and also whose angle and length are smaller than point 2. A load correction factor will not be applied to boom positions outside of this zone.

Case 2

This shows the influence of adding one additional calibration point to case 1, the pair of numbers in each sub-zone show the calibration points used to determine the load correction factor calculated for various points in that sub-zone.

Case 3

This shows a typical set of calibration points that will go on to use the most logical adjacent points for interpolation purposes and also cover the full working range of the machine.

Case 4

This shows a more practical set of calibration points that will improve the most likely area for load errors.

Case 5 and 6

These show the results of excluding one or more of the calibration points chosen in case 4.

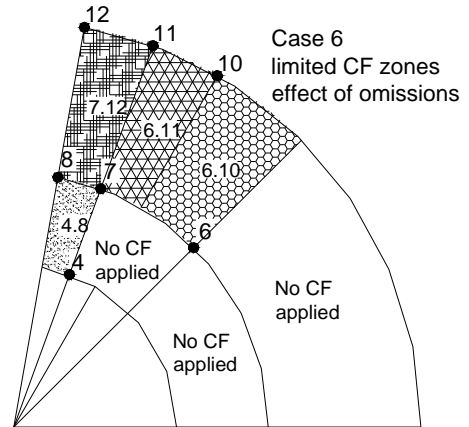
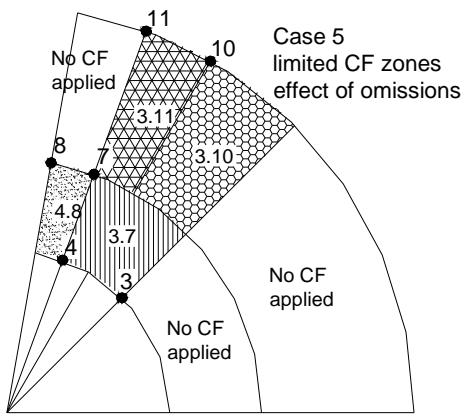
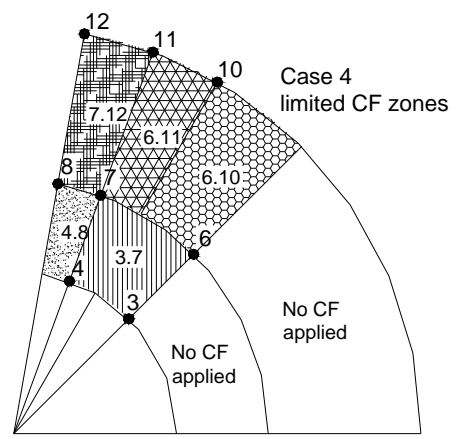
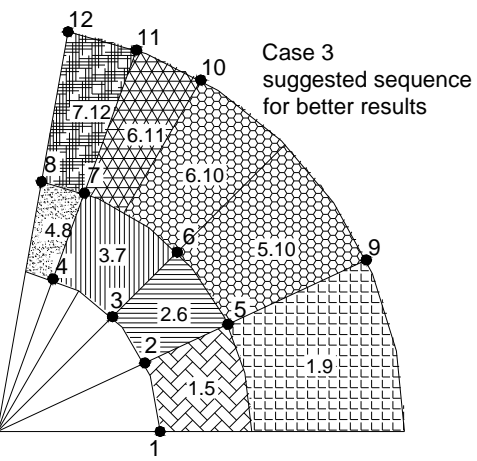
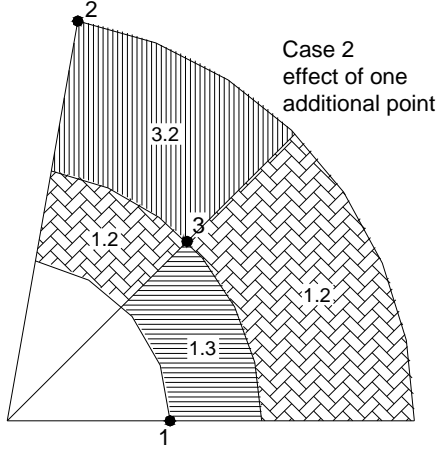
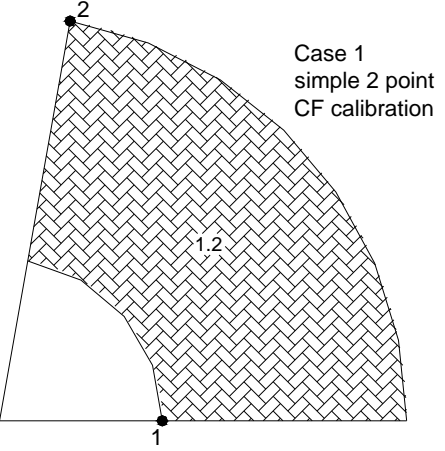

Only one load correction factor is stored at each angle/length location and the test load used to set this factor should represent greater than 50% of the Safe Working Load at each location. Calibrating a load correction factor with smaller test loads could result in unacceptable errors at 100% SWL.

To add a load correction calibration point, ensure the current duty selection matches the actual crane configuration being used for the calibration. Navigate through the calibration menu using “↑” or “↓” to highlight “load correction” and press “✓” to enter.

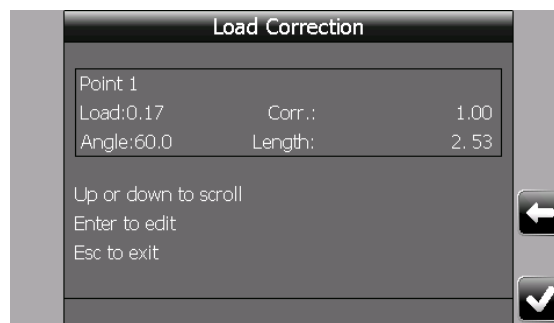

Where **Load:** represents the suspended load reading and **Corr.: 1.00** represents the adjustment factor (a value of 1.00 signifies that there is no applied adjustment). **Angle** and **Length** are the current values for the machine position. The **Point** number will be 1 for the first calibration, otherwise it will be the first available, uncalibrated point. Press “✓” to highlight the corr. value for editing.

Position the boom to the required angle and length and carefully lift the test load until it is just clear of the ground.

Adjust the corr. value until the displayed load equals the suspended test load.

Press “✓” to accept the change, the system will confirm the calibration is saved, press “←” to return to the main calibration menu. Carefully replace the test load on the ground.

Repeat this procedure to enter a second and subsequent load correction points as required.

Existing load correction points can be deleted if required, select the screen above but use button “↓” to decrease the point number to the one that is not required. The display will show :

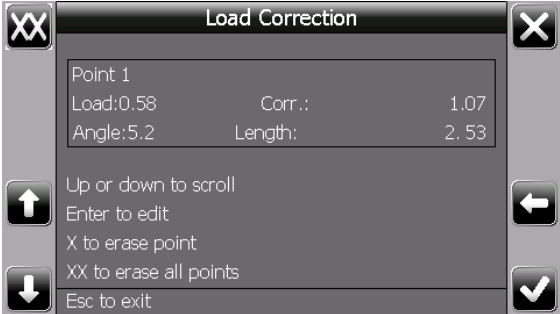

This screen will show the data stored for the selected calibration point rather than current data, press “X” to select this point for deletion from the calibration memory.

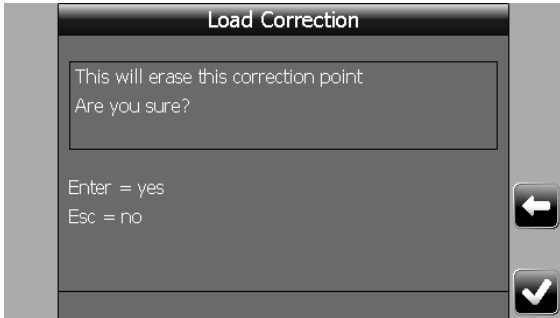

Press “✓” to accept the deletion, the system will confirm this calibration point is deleted, press “←” to return to the main calibration menu.

To erase all load correction points for this configuration, enter the load correction calibration screen and select any existing calibration point, press “XX” to select all points for deletion from the calibration memory.

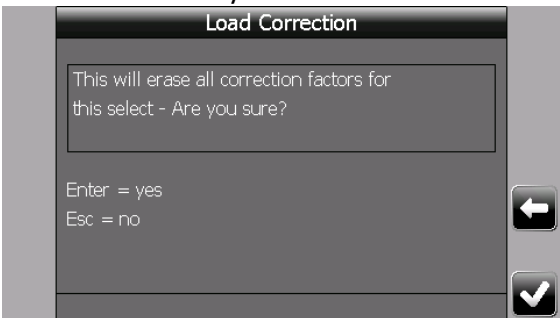

Press “✓” to accept the deletion, the system will confirm all load correction calibration points are deleted for this duty, press “←” to return to the main calibration menu. Note the load correction calibration should always be cleared before proceeding with a no load calibration, see section 3.5.

7 ANNEX 2 – Menu cross reference

Note: Items marked # are options and not available in all software versions.

Item	Manual section	Main boom duty	Jib/attachment duty
Select sensors	3.1	✓	✓
Zero sensor	3.1	✓	✓
Span sensor or side of boom angle	3.2	✓	✓
Select pressure transducer	3.3	✓	✓
Zero pressure	3.3	✓	✓
Span pressure	3.3	✓	✓
Block capacities and block weights	2.6	✓	✓
Select boom output sequence **	3.4	✓	✓
Boom output sequence info **	3.4	✓	✓
No load calibration	3.5	✓	Not used
Unloaded boom deflection	3.6	✓	--
Loaded boom deflection	3.7	✓	--
Jib deflection	3.11	--	✓
Load correction	3.10	✓	Not used
Load adjustment	3.8	✓	--
	3.12	--	✓
Load offset	3.9	✓	--
	3.13	--	✓
Memory	3.17	✓	✓
Crane type #	2.8	✓	✓
Calibration data	2.4	✓	✓
Dimensions	2.5	✓	✓
Friction compensation	3.14	✓	✓
Limits setting (if no slew encoder fitted)	4.1	✓	✓
Rotation data (if slew encoder fitted)	4.4	✓	✓
Bridging/bypass output #	2.9	✓	✓
Enable/disable i/o	2.2	✓	✓
Enable/disable jibs #	2.8	✓	✓
GPIO Hdins configuration *	2.2	✓	✓
Calibration units:	2.3	✓	✓
System options	2.7	✓	✓
Special calibration #	4.2	✓	✓
Picture	2.10	✓	✓
Transfer	3.15	✓	✓
	3.16		
Fault log	5.1	✓	✓
Event recorder	5.2	✓	✓
Users ID	4.3	✓	✓

*Only available if GPIO HDIN/HDOUT is enabled

** Only available if more than one boom length sensor is fitted